

Service Manual

Turntable System

SL-1200MK2

[M], [MC],

[E], [EK], [XL], [EG], [EB], [EH],

[EF], [Ei], [XA], [PA], [PE], [PC]

SL-1210MK2

[E], [EG], [EH]

Supplement

audiovias.com



*SL-1200MK2 is the model for silver type.

*SL-1210MK2 is the model for black type of SL-1200MK2.

Areas

- * [M] is available in the U.S.A.
- * [MC] is available in Canada.
- * [E] is available in Switzerland and Scandinavia.
- * [EK] is available in United Kingdom.
- * [XL] is available in Australia.
- * [EG] is available in F.R. Germany.
- * [EB] is available in Belgium.
- * [EH] is available in Holland.
- * [EF] is available in France.
- * [Ei] is available in Italy.
- * [XA] is available in Southeast Asia, Oceania, Africa, Middle Near East and Central South America.
- * [PA] is available in far East PX.
- * [PE] is available in European Military.
- * [PC] is available in European Audio Club.

Please use this manual together with the service manual for Model No. SL-1200MK2/1210MK2.

English

Inclusive SM & Changes

Specifications

Specifications are subject to change without notice for further improvement.
Weight and dimensions shown are approximate.

General

Power supply:	120V, AC 60 Hz (For [M], [MC] areas) ~ 110-120/220-240V, 50 or 60 Hz (For other areas)
Power consumption:	14 W (For [M], [MC] areas) 13.5 W (For other areas)
Dimensions: (W x H x D)	45.3 x 16.2 x 36 cm (17-27/32" x 6-19/64" x 14-11/64")
Weight:	12.5 kg (27.6 lb)

Turntable section

Type:	Quartz direct drive Manual turntable
Drive method:	Direct drive
Motor:	Brushless DC motor

Turntable platter:	Aluminum diecast Diameter 33.2 cm (13-5/64") Weight 2 kg (4.4 lb)
Turntable speeds:	33-1/3 rpm and 45 rpm
Starting torque:	1.5 kg · cm (1.3 lb · in)
Build-up characteristics:	0.7 s. from standstill to 33-1/3 rpm
Braking system:	Electronic brake
Wow and flutter:	0.01% WRMS* 0.025% WRMS (JIS C5521) ± 0.035% peak (IEC 98A Weighted)

* This rating refers to turntable assembly alone, excluding effects of record, cartridge or tonearm, but including platter.
Measured by obtaining signal from built-in frequency generator of motor assembly.

Rumble:	-56 dB (IEC 98A Unweighted) -78 dB (IEC 98A Weighted)
----------------	--

Matsushita Engineering and Service Company
50 Meadowland Parkway,
Secaucus, New Jersey 07094

Panasonic Hawaii Inc.
91-238 Kahuhi St. Ewa Beach
P.O. Box 774
Honolulu, Hawaii 96808-0774

Panasonic Sales Company,
Division of Matsushita Electric of Puerto Rico, Inc.
Ave. 65 De Infanteria, KM 9.7
Victoria Industrial Park
Carolina, Puerto Rico 00630

Matsushita Electric of Canada Limited
5770 Ambler Drive, Mississauga,
Ontario, L4W 2T3

Technics

Panasonic Tokyo
Matsushita Electric Industrial Co., Ltd.
1-2, 1-chome, Shibakoen, Minato-ku, Tokyo 105 Japan

Matsushita Electric Trading Co., Ltd.
P.O. Box 288, Central Osaka Japan

www.audiovias.com

SL-1200MK2/1210MK2

■ Tonearm section

Type:	Universal
Effective length:	230 mm (9-1/16")
Arm height adjustment range:	0 – 6 mm
Overhang:	15 mm (19/32")
Effective mass:	12 g (without cartridge)
Offset angle:	22°
Friction:	Less than 7 mg (lateral, vertical)
Tracking error angle:	Within 2°32' (at the outer groove of 30 cm (12") record Within 0°32' (at the inner groove of 30 cm (12") record)

Stylus pressure adjustment range:	0 – 2.5 g
Applicable cartridge weight range:	6 – 10 g
(with auxiliary weight):	13.5 – 17.5 g (including headshell)
(with shell weight):	9.5 – 13 g
(with shell weight):	17 – 20.5 g (including headshell)
(with shell weight):	3.5 – 6.5 g
(with shell weight):	11 – 14 g (including headshell)
Headshell weight:	7.5 g

Notes

- ★ To improve the performance of SL-1200MK2/1210MK2, the bottom structure and circuit are changed in the course of production.
- ★ After the change, SL1200MK2-A/1210MK2-A is indicated in the name plate as the model of the set. It is discriminated from before-change set by -A. Also, check that the present change is of the sets after the change mark **D** shown in the serial No. sheet attached to the bottom and carton box.
- ★ This supplement service manual contains the bottom plate disassembly procedure, change part No., circuit diagram, P.C.B. and block diagrams. The other contents are the same as for the service manual of SL-1200MK2/1210MK2 already issued.
- ★ Sets with cartridge (EPC-207C) are included in those for same areas.
- ★ Since the power transformer fitting method is different for sets with serial number sheet change mark **E**, refer to the development plan on page 8.

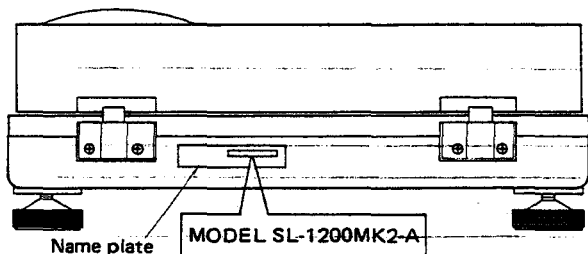

Name plate MODEL SL-1200MK2-A

Serial No. sheet

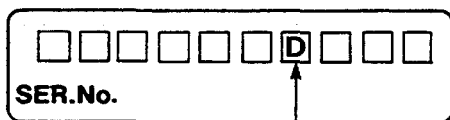

SER.No.

Change mark

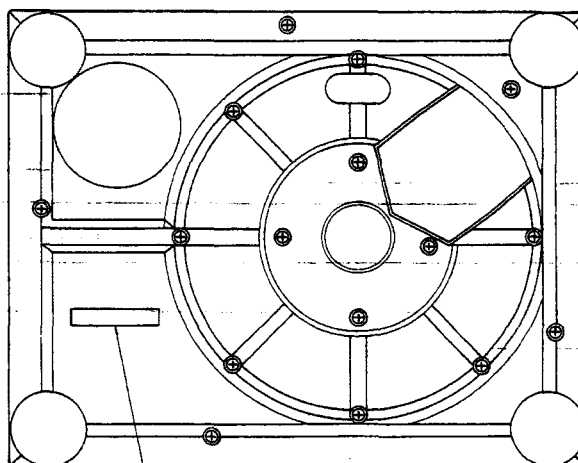

Serial No. sheet

Deutsch

TECHNISCHE DATEN

Änderungen der technischen Daten vorbehalten.
Die angegebenen Gewichts- und Abmessungsdaten sind ungefähre Werte.

■ Allgemeine Daten

Stromversorgung:	~ 110-120/220-240 V, 50/60 Hz Wechselstrom
Leistungsaufnahme:	13,5 W
Abmessungen:	
(B x H x T):	45,3 x 16,2 x 36 cm
Gewicht:	12,5 kg

■ Plattenspieler

Typ:	Manueller Quarz-Direktantrieb- Plattenspieler
Antrieb:	Direktantrieb
Motor:	Kollektorloser Gleichstrommotor
Plattenteller:	Aluminium-Spritzguß Durchmesser 33,2 cm Gewicht 2 kg

Plattenteller-Drehzahlen:	33-1/3 und 45 U/min
Aniandrehmoment:	1,5 kg · cm
Drehzahl-Hochlaufzeit:	0,7 s. vom Stillstand auf 33-1/3 U/min
Bremssystem:	Elektronische Bremse
Gleichlaufschwankungen:	0,01% WRMS* 0,025% WRMS (JIS C5521) ± 0,035% Spitze (IEC 98A bewertet)

* Diese Nennleistung bezieht sich auf das Laufwerk-Bauteil allein, ausschließlich Einflüsse von Schallplatte, Tonabnehmer oder Tonarm, aber einschließlich Plattenteller. Gemessen anhand von Signalen vom eingebauten Frequenzgenerator des Motorbauteils.

Rumpel-Geräuschspannungsabstand:	-56 dB (IEC 98A unbewertet) -78 dB (IEC 98A bewertet)
---	--

■ Tonarm

Typ:	Universal-Tonarm	Auflagekraft-	
Effektive Länge:	230 mm	Einstellbereich:	0 – 2,5 g
Tonarmhöhe-		Zulässiger Tonabnehmer-	
Einstellbereich:	0 – 6 mm	Gewichtsbereich:	6 – 10 g
Überhang:	15 mm		13,5 – 17 g (einschließlich Tonarmkopf)
Effektive Masse:	12 g (ohne Tonabnehmer)	(mit Zusatz-	
Spurfehlwinkel:	2°32' bei der Einlaufrille einer 30 cm-Platte	Gegengewicht):	9,5 – 13 g
	0°32' bei der Auslaufrille einer 30 cm-Platter	Gewichtsbereich:	17 – 20,5 g (einschließlich Tonarmkopf)
Kröpfungswinkel:	22°	(mit Zusatzgewicht)	3,5 – 6,5 g
Lagerreibung:	Weniger als 7 mg (horizontal, vertikal)	Tonarmkopf-Gewicht:	7,5 g

Français

CARACTERISTIQUES

Les spécifications sont susceptibles d'être modifiées sans préavis.
Le poids et les dimensions donnés sont approximatifs.

■ Généralités

Alimentation:	Alternatif 110-120/220-240 V, 50 ou 60 Hz
Consommation:	13,5 W
Dimensions: (L x H x P)	45,3 x 16,2 x 36 cm
Poids:	12,5 kg

■ Platine de lecture

Type:	Entaînement direct à quartz Platine manuelle
Système d'entraînement:	Entraînement direct
Moteur:	Moteur C.C. sans balai
Plateau de lecture:	Aluminium moulé sous pression Diamètre 33,2 cm Poids 2 kg
Vitesses de rotation:	33-1/3 et 45t/p.m.
Couple de démarrage:	1,5 kg · cm
Caractéristiques d'augmentation:	0,7 s. (rotation de 90°) à 33-1/3 t/p.m.
Système de freinage:	Frein électronique
Pleurage et scintillement:	0,01% de valeur efficace* 0,025% de valeur efficace (JIS C5521) ± 0,35% de crête (IEC 98A Pondéré)

*Ce régime nominal se rapporte à l'ensemble du tournedisque seul, excluant les effets du disque, de la cellule pick-up ou de bras de lecture, mais comprenant le plateau.

Mesuré par l'obtention d'un signal provenant du générateur de fréquences incorporé de l'ensemble du moteur.

Ronflement:	–56 dB (IEC 98A Non pondéré)
	–78 dB (IEC 98A Pondéré)

■ Bras de lecture

Type:	Bras de lecture universel
Longueur effective:	230 mm
Portée du réglage de la hauteur de bras:	0 – 6 mm
Porte-à-faux:	15 mm
Masse réelle:	12 g (sans la cellule pick-up)
Angle d'erreur de piste:	En deçà de 2°32' au sillon extérieur d'un disque de 30 cm En deçà de 0°32' au sillon intérieur d'un disque de 30 cm
Angle de décalage:	22°
Frottement:	Moins de 7 mg (latéral et vertical)
Plage de réglage de la pression d'appui:	0 – 2,5 g
Gamme du poids de la cellule pick-up utilisable:	6 – 10 g 13,5 – 17,5 g (y compris la coque porte-cellule)
(avec contreponds auxiliaire):	9,5 – 13 g 17 – 20,5 g (y compris la coque porte-cellule)
(avec contreponds de la cellule):	3,5 – 6,5 g 11 – 14 g (y compris la coque porte-cellule)
Poids de la cellule:	7,5 g

ESPECIFICACIONES

Las especificaciones quedan sujetas a cambios sin aviso previo.
El peso y las dimensiones indicados son aproximados.

■ En general

Alimentación de corriente:	~ 110-120/220-240 V, 50 ó 60 Hz
Consumo de corriente:	13,5 W
Dimensiones: (Ancho x Alto x Prof.)	45,3 x 16,2 x 36 cm
Peso:	12,5 kg

■ Sección del plato giratorio

Tipo:	Plato giratorio manual de accionamiento directo por cuarzo
Método de accionamiento:	Accionamiento directo
Motor:	Motor de corriente continua sin escobillas
Platillo del plato giratorio:	Aluminio fundido Diámetro 33,2 cm Peso 2 kg.
Velocidades del plato giratorio:	33-1/3 y 45 rpm
Par motor de arranque:	1,5 kg · cm
Características de establecimiento:	0,7 s. (a partir de reposo) hasta 33-1/3 rpm
Sistema de frenado:	Freno electrónico
Ululaciones y trémolo:	0,01% WRMS* 0,025% WRMS (JIS C5521) ± 0,035% cresta (IEC 98A Ponderado)

*Estas características se refieren únicamente al conjunto del plato giratorio, con exclusión de los efectos provenientes del disco, cartucho o del brazo sonoro, incluyendo, empero, el platillo. La medida fue tomada por medio de la señal obtenida del generador de frecuencia incorporado del conjunto del motor.

Ruido de rodadura:	-56 dB (IEC 98A No Ponderado) -78 dB (IEC 98A Ponderado)
---------------------------	---

■ Sección del brazo sonoro

Tipo:	Brazo sonoro universal
Longitud efectiva:	230 mm
Radio de ajuste de altura del brazo:	0 - 6 mm
Parte saliente:	15 mm
Masa efectiva:	12 g. (sin cartucho)
Angulo de descentramiento:	22°
Fricción:	Menos de 7 mg. (en sentido lateral y vertical)
Angulo de error de seguimiento:	Inferior a 2°32' en el surco exterior de un disco de 30 cm Inferior a 0°32' en el surco interior de un disco de 30 cm
Radio de ajuste de la presión de la aguja:	0 a 2,5 g.
Radio de peso de cartucho utilizable:	6 a 10 g. 13,5 a 17,5 g. (incluyendo la cápsula de la cabeza)
(con contrapeso de balanza de reserva):	9,5 a 13 g. 17 a 20,5 g. (incluyendo la cápsula de la cabeza)
(con contrapeso de la cápsula):	3,5 a 6,5 g. 11 a 14 g. (incluyendo la cápsula de la cabeza)
Peso de la cápsula de la cabeza:	7,5 g

CHANGES

■ DISASSEMBLY INSTRUCTIONS

• How to remove the bottom cover and bottom base.

1. Remove the turntable mat and turntable.
2. Turn over the body on a soft cloth taking care not to damage the dust cover.
3. Remove the insulators and the 21 setscrews (Fig. 1 : ①, ②, ③) of the bottom cover.
4. Remove the 6 setscrews (Fig. 2 : ④) of the bottom base.

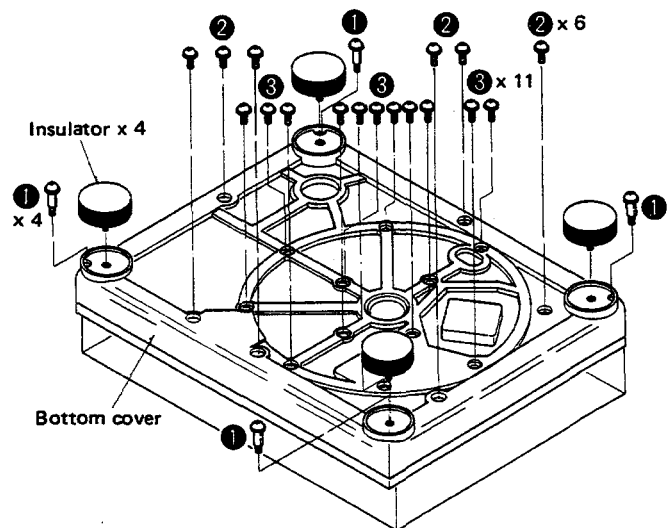

Fig. 1

Supplement

● How to remove the hinge case

1. Remove the bottom cover. (Refer to "How to remove the bottom cover".)
2. Remove the 4 setscrews (Fig. 2 : ⑤) of the hinge case bracket.

3. Remove the 4 setscrews (Fig. 2 : ⑥) of the hinge case.

Note: The other disassembly procedure are the same as for before-change sets.

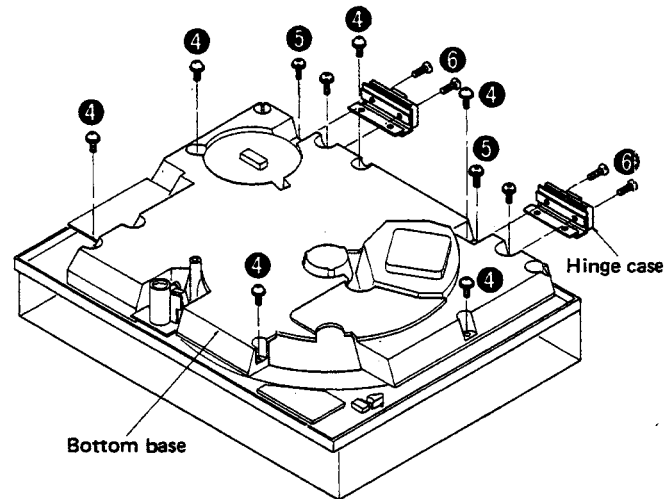

Fig. 2

■ REPLACEMENT PARTS LIST

Notes:

1. This parts list mentions only the difference between before and after change of SL-1200MK2/1210MK2.
2. ⊗-marked parts are used only for SL-1210MK2 (black type). And ○-marked parts are used for SL1200MK2 (silver type).
3. Parts other than ⊗- and ○-marked are used for both SL-1210MK2 and SL-1200MK2.
4. The "Ⓢ" mark is service standard parts and may differ from production parts.

Areas

- * [M] is available in the U.S.A.
- * [MC] is available in Canada.
- * [E] is available in Switzerland and Scandinavia.
- * [EK] is available in United Kingdom.
- * [XL] is available in Australia.
- * [EG] is available in F.R. Germany.
- * [EB] is available in Belgium.
- * [EH] is available in Holland.
- * [EF] is available in France.
- * [Ei] is available in Italy.
- * [XA] is available in Southeast Asia, Oceania, Africa, Middle Near East and Central South America.
- * [PA] is available in far East PX.
- * [PE] is available in European Military.
- * [PC] is available in European Audio Club.

Ref. No.	Change of Part No.		Part Name & Description	Per Set (Pcs.)	Remarks
	SL-1200MK2 (Before Change)	SL-1200MK2/1210MK2 (After Change)			
INTEGRATED CIRCUIT					
IC302	SVITC4011BP	MN4011B	NAND Gate	1	
TRANSISTOR					
Q1	2SD389A-Q	2SD1265	Regulator	1	
DIODES					
D1	SVDS1RBA40	SVDS1RBA20Z	Rectifier	1	△
D201, 202	SVDSR-105C	SVDPR3902S-9	Speed Indicator	2	
D203 ~ 206	SVDEBR5505S	SVDSLH54VT3	Strobe	4	
D401	SVDGL-9PG2	SVDGL-9NG2	Pitch Indicator	1	
CRYSTAL					
X201	SVQU306115	SVQMS4193	4.193 MHz, Oscillator	1	
VARIABLE RESISTORS					
VR301	EVMH2GA00B53	EVMH1GA00B23	Pitch Control Adjustment, 2kΩ (B)	1	
VR303	EVB05C19ABE	SFDZ122N11	Pitch Control	1	
SWITCHES					
S203	SFDSS5GL13C	SFDSS01GL13	Start/Stop	1	
S601	SFDSS5GL13S	SFDSS5GL13P	Power	1	△
TRANSFORMER					
T1	SLT60EU7B	SLT66DTL3A [M]	Power Source	1	△
T1	SLT60E31C	SLT66DT14C [MC]	Power Source	1	△
T1	SLTF5900	SLT66DTE13A [Other areas]	Power Source	1	△

SL-1200MK2/1210MK2

Ref. No.	Change of Part No.		Part Name & Description	Per Set (Pcs.)	Remarks
	SL-1200MK2 (Before Change)	SL-1200MK2/1210MK2 (After Change)			
RESISTORS					
R4	ERD25FJ561	ERD25FJ471	Carbon, 1/4W, 470Ω	1	Ⓢ
R209	ERD25TJ154	ERD25TJ334	Carbon, 1/4W, 330kΩ	1	Ⓢ
R211	ERD25FJ103	ERD25FJ472	Carbon, 1/4W, 4.7kΩ	1	Ⓢ
R212	ERD25FJ121	ERD25FJ151	Carbon, 1/4W, 150Ω	1	Ⓢ
R222	Addition	ERD25FJ391	Carbon, 1/4W, 390Ω	1	Ⓢ
R301	ERO25CKF3301	ERO25CKF2701	Metal Film, 1/4W, 2.7kΩ	1	Ⓢ
R304	ERD25FJ152	ERD25FJ561	Carbon, 1/4W, 560Ω	1	Ⓢ
R401	Addition	ERD50FJ152	Carbon, 1/2W, 1.5kΩ	1	Ⓢ
R601	ERD25FJ4R7	ERD50FJ4R7	Carbon, 1/2W, 4.7Ω	1	⚠ Ⓢ
CAPACITORS					
C5, 6	Addition	ECQM1223KZ	Polyester, 125V, 0.022μF	1	⚠
C104 ~ 107	ECQM1H104KZ	ECQM1H104JZ	Polyester, 50V, 0.1μF	4	Ⓢ
C109, 110	ECQM1H104KZ	ECQM1H104JZ	Polyester, 50V, 0.1μF	2	Ⓢ
C111	ECQM1H562KZ	ECQM1H562JZ	Polyester, 50V, 0.0056μF	1	Ⓢ
C204	ECQM1H473KZ	ECQM1H473JZ	Polyester, 50V, 0.047μF	1	Ⓢ
C210	ECQM1H224KZ	ECQM1H224JZ	Polyester, 50V, 0.22μF	1	Ⓢ
C211	ECQM1H473KZ	ECQM1H473JZ	Polyester, 50V, 0.047μF	1	Ⓢ
C217 ~ 219	Addition	ECKD1H104ZF	Ceramic, 50V, 0.1μF	1	Ⓢ
C301	ECQK1123FZ	ECQK1333GZ	Polyester, 125V, 0.033μF	1	
C302	ECQK1123FZ	ECQK1682GZ	Polyester, 125V, 0.0068μF	1	
C305	ECQM1H122KZ	ECQM1H122JZ	Polyester, 50V, 0.0012μF	1	Ⓢ
CABINET and CHASSIS PARTS					
9	SFUP122-12	Deletion	-----	0	
10	SFAC122-01	SFAC122-01	Cabinet (Silver)	1	○
		SFAC124S01	Cabinet (Black)	1	Ⓚ
25	SFXB122-02	SFXB122-06	Boss, Drive	1	
33	SFQA001-02	SFQA122-03	Spring	1	
36	SFUP025-01	SFUP122-16 [M, MC, PA, PE, PC]	Bracket, AC Cord	1	
	SFUP025X01	SFUP122X01 [Other areas]	Bracket, AC cord	1	
38	SFUP132-03	SFGC122-03	Cushion	2	
40	SFUP122-10	Deletion	-----	0	
42	SFKK122-03	SFKK122-03	Plate (Silver)	1	
		SFKK124S01	Plate (Black)	1	
48	SFAU122-01	SFAU122-02	Bottom Base	1	
48-1	Addition	SFAU122-03	Bottom Cover	1	
49	SFUP122-05	SFUP122-23	Supporter (A), Hinge	2	
50	SFUP122-04	SFUP122-24	Supporter (B), Hinge	2	
51	SFUM170-07	SFUMM02N04	Case, Hinge	2	
55	SFNN122M01	SFNN122M10 [M]	Name Plate	1	○
	SFNN122C01	SFNN122C10 [MC]	Name Plate	1	○
	SFNN122S01	SFNN122S10 [E]	Name Plate	1	○
	SFNN122L01	SFNN122G10 [EK, XL]	Name Plate	1	○
	SFNN122X01	SFNN122X10 [XA]	Name Plate	1	○
	Addition	SFNN122P10 [PA, PE]	Name Plate	1	○
	Addition	SFNN122P11 [PC]	Name Plate	1	○
	SFNN122N01	SFNN122N10 [Other areas]	Name Plate	1	○
	Addition	SFNN124S10 [E]	Name Plate	1	Ⓚ
Addition	SFNN124Q10 [EG, EH]	Name Plate	1	Ⓚ	
56	SFX0122-01	Deletion	-----	0	
57	SFX0122-02	Deletion	-----	0	
58	SFAT122-01A	SFATM02N01A	Hinge	1	

SL-1200MK2/1210MK2

Ref. No.	Change of Part No.		Part Name & Description	Per Set (Pcs.)	Remarks
	SL-1200MK2 (Before Change)	SL-1200MK2/1210MK2 (After Change)			
TO NEARM PARTS					
62	SFPAM18201K	SFPAM18201K	Tonearm Ass'y (Silver)	1	○
		SFPAM18202K	Tonearm Ass'y (Black)	1	Ⓚ
79	SFPKB17201S	SFPKB17204E	Ring, Arm Base Operation	1	
82	SFGK132-01	SFGK132-01	Cap (Silver)	1	○
		SFGK133S01	Cap (Black)	1	Ⓚ
ACCESSORIES					
A1	SFNU122M01	SFNU122M06 [M]	Instruction Book	1	
	SFNU122C01	SFNU122C06	Instruction Book	1	
	SFNU122S01	SFNU122S01 [E]	Instruction Book	1	
	SFNU122G01	SFNU122G01 [EK]	Instruction Book	1	
	Addition	SFNU122P01 [PA, PE, PC]	Instruction Book	1	
	SFNU122X01	SFNU122X01 [Other areas]	Instruction Book	1	
A2	SFWE010	SFWE122-01	45 Adaptor	1	
PACKING PARTS					
P1	SFHP122C01	SFHP122C02 [MC, EF]	Carton Box (Silver)	1	○
		SFHP122M02 [Other areas]	Carton Box (Silver)	1	○
	SFHP122M01	SFHP124S02	Carbon Box (Black)	1	Ⓚ
P9	Addition	SPB10B3	Polyethylene Bag, Accessories	2	
P10	Addition	SPJ15	Polyethylene Bag, Shell Weight	1	
P11	Addition	SFHZD03M01	Polyethylene Bag, Dust Cover	3	
P12	Addition	SFHZ122-01	Polyethylene Bag, 45 Adaptor	1	
P13	Addition	SPP189	Polyethylene Bag, Cords	2	

■ ADJUSTMENT POINTS

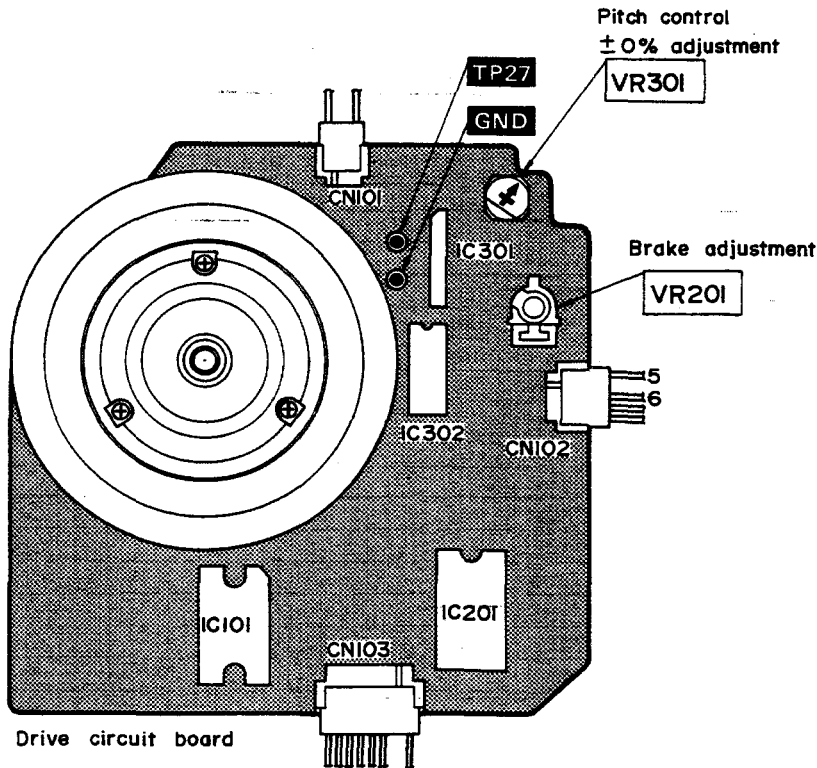

Fig. 3 (Abb. 3)

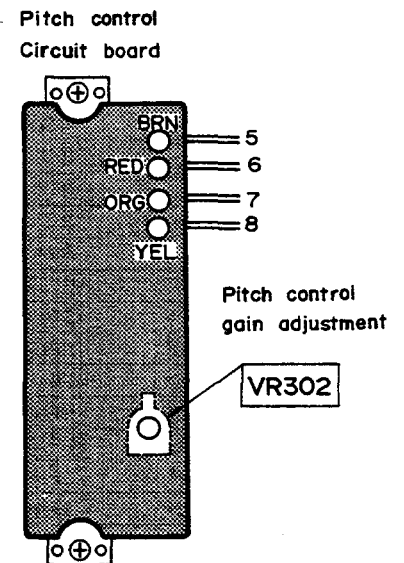

Fig. 4 (Abb. 4)

MEASUREMENTS AND ADJUSTMENTS English

• Conditions of set, and instruments used

1. Remove the panel cover.
2. Remove the bottom cover (when adjusting the pitch control gain).
3. Frequency counter
4. Tester

	Adjustment	Connection	Parts adjusted	Procedure
1	Pitch control $\pm 0\%$ adjustment	Frequency counter (+) – TP27 (–) – Earth point	VR301 (Fig. 3)	<ol style="list-style-type: none"> 1. Connect the frequency counter and turn the power supply ON. 2. Set the pitch control knob to "0". (Indicator lights up.) 3. Adjust VR301 so that the frequency is 262.08 kHz \pm 0.05 kHz.
2	Pitch control gain adjustment	Tester (+) – CN102 terminal ⑤ (–) – CN102 terminal ⑥	VR302 (Fig. 4)	<ol style="list-style-type: none"> 1. Set the pitch control knob to "0". 2. Pull out the connector CN102 of drive P.C.B. 3. Connect the tester to terminals ⑤ and ⑥ of connector CN102 on the pitch control P.C.B. side. 4. Adjust VR302 so that the resistance value of the tester is 2.7 kΩ \pm 0.1 kΩ.
3	Brake adjustment	_____	VR201 (Fig. 3)	<ol style="list-style-type: none"> 1. Adjust VR201 so that the rotation at 33 r.p.m. stops within the angle of 90° ~ 120° after depressing the stop button.

MESSUNGEN UND JUSTIERUNGEN Deutsch

• Zustand des Gerätes und zu verwendende Instrumente

1. Die Abdeckplatte entfernen.
2. Die Bodenabdeckung entfernen (wenn die Drehzahlregelungs-Verstärkung justiert werden soll).
3. Frequenzzähler
4. Prüfgerät

	Justierung	Anschlüsse	Zu justie- render Teile	Vorgehen
1	$\pm 0\%$ -Justierung des Drehzahlreglers	Frequenzzähler (+) – TP27 (–) – Massepunkt	VR301 (Abb. 3)	<ol style="list-style-type: none"> 1. Frequenzzähler anschließen und Netzschalter einschalten. 2. Drehzahlreglerknopf auf "0" stellen. (Anzeige leuchtet auf.) 3. VR301 so justieren, daß die Frequenz 262,08 kHz \pm 0,05 kHz beträgt.
2	Justierung der Drehzahlregelungs-Verstärkung	Prüfgerät (+) – CN102 Anschluß ⑤ (–) – CN102 Anschluß ⑥	VR302 (Abb. 4)	<ol style="list-style-type: none"> 1. Den Drehzahlreglerknopf auf "0" einstellen. 2. Steckverbindung CN102 von der Antriebsplatte herausziehen. 3. Prüfgerät an Anschlüsse ⑤ und ⑥ der Steckverbindung CN102 auf der Drehzahlreglerseite der Platine anschließen. 4. VR302 so justieren, daß der Widerstandswert des Prüfgerätes 2,7 kΩ \pm 0,1 kΩ beträgt.
3	Bremsjustierung	_____	VR201 (Abb. 3)	<ol style="list-style-type: none"> 1. VR201 so justieren, daß die Rotation bei 33 UPM innerhalb 90° ~ 120° nach Drücken der Stop-Taste stoppt.

MESURAGES ET RÉGLAGES

Français

• Conditions de l'appareil et appareils utilisés.

1. Retirer le panneau de protection.
2. Retirer le panneau de protection inférieur (lors de l'ajustement de l'amplification du réglage d'écart).
3. Compteur de fréquence
4. Appareil contrôleur

	Mise au point	Raccordement	Elements à regler	Marche à suivre
1	Ajustement de $\pm 0\%$ du réglage d'écart	Compteur de fréquence (+) – TP27 (–) – Point de contact à la terre	VR301 (Fig. 3)	<ol style="list-style-type: none"> 1. Raccorder le compteur de fréquence et mettre en marche l'alimentation. 2. Régler le bouton du réglage d'écart sur "0". (L'indicateur s'éclairera.) 3. Ajuster VR301 de telle sorte que la fréquence soit de $262,08 \text{ kHz} \pm 0,05 \text{ kHz}$.
2	Ajustement de l'amplification du réglage d'écart	Appareil contrôleur (+) – Borne CN102 ⑤ (–) – Borne CN102 ⑥	VR302 (Fig. 4)	<ol style="list-style-type: none"> 1. Régler le bouton de réglage d'écart sur "0". 2. Retirer le connecteur CN102 de la plaquette à circuits imprimés de commande. 3. Raccorder l'appareil contrôleur aux bornes ⑤ et ⑥ du connecteur CN102 sur le côté de la plaquette à circuits imprimés du réglage d'écart. 4. Ajuster VR302 de telle sorte que la valeur de résistance de l'appareil contrôleur soit de $2,7 \text{ k}\Omega \pm 0,1 \text{ k}\Omega$.
3	Ajustement du frein		VR201 (Fig. 3)	<ol style="list-style-type: none"> 1. Régler VR201 de telle sorte que la rotation à 33 t/p.m. s'arrête en deçà d'un angle de $90^\circ \sim 120^\circ$ après avoir appuyé sur la touche d'arrêt.

MEDICIONES Y AJUSTE

Español

• Condiciones de aparato e instrumentos usados

1. Remover la cubierta del panel.
2. Remover la cubierta inferior (al ajustar la ganancia de control de altura de los sonidos).
3. Contador de frecuencia
4. Probador

	Ajuste	Conexión	Piezas ajustadas	Procedimiento
1	Ajuste $\pm 0\%$ de control de altura	Contador de frecuencia (+) – TP27 (–) – Punto de tierra	VR301 (Fig. 3)	<ol style="list-style-type: none"> 1. Conectar el contador de frecuencia y prender la fuente de alimentación. 2. Ajustar la perilla de control de altura de sonidos a "0". (El indicador se ilumina.) 3. Ajustar VR301 de manera que la frecuencia sea $262,08 \text{ kHz} \pm 0,05 \text{ kHz}$.
2	Ajuste de ganancia de control de altura	Probador (+) – Terminal de CN102 ⑤ (–) – Terminal de CN102 ⑥	VR302 (Fig. 4)	<ol style="list-style-type: none"> 1. Poner el control de altura de sonidos en "0". 2. Sacar el conector CN102 de T.C.I. de accionamiento. 3. Conectar el probador a terminales ⑤ y ⑥ de conector CN102 del lado de T.C.I. de control de altura. 4. Ajustar VR302 de manera que el valor de resistencia del probador sea $2,7 \text{ k}\Omega \pm 0,1 \text{ k}\Omega$.
3	Ajuste de freno		VR201 (Fig. 3)	<ol style="list-style-type: none"> 1. Ajustar VR201 de manera que la rotación a 33 r.p.m. se pare dentro del ángulo de $90^\circ \sim 120^\circ$ después oprimir el botón de parada

RESISTORS AND CAPACITORS

- Notes:**
- Part numbers are indicated on most mechanical parts. Please use this part number for parts orders.
 - Important safety notice: Components identified by Δ mark have special characteristics important for safety. When replacing any of these components use only manufacturer's specified parts.
 - The "S" mark is service standard parts and may differ from production parts.
 - Bracketed indications in Ref. No. column specify the area. Parts without these indications can be used for all area.
 - The unit of resistance is Ω (ohm).
K = 1000 Ω , M = 1000k Ω
 - The unit capacitance is μF (microfarad).
P = 10^{-6} μF

Areas

- * [M] is available in the U.S.A.
- * [MC] is available in Canada.
- * [E] is available in Switzerland and Scandinavia.
- * [EK] is available in United Kingdom.
- * [XL] is available in Australia.
- * [EG] is available in F.R. Germany.
- * [EB] is available in Belgium.
- * [EH] is available in Holland.
- * [EF] is available in France.
- * [Ei] is available in Italy.
- * [XA] is available in Southeast Asia, Oceania, Africa, Middle Near East and Central South America.
- * [PA] is available in far East PX.
- * [PE] is available in European Military.
- * [PC] is available in European Audio Club.

Numbering System of Resistor

Example

ERD	25	F	J	101
Type	Wattage	Shape	Tolerance	Value
ERX	2	AN	J	2R2
Type	Wattage	Shape	Tolerance	Value

Numbering System of Capacitor

Example

ECKD	1H	102	Z	F
Type	Voltage	Value	Tolerance	Peculiarity
ECEA	50	M	R47	R
Type	Voltage	Recularity use	Value	Special use

Resistor type	Wattage	Tolerance
ERD: Carbon	25 : 1/4W	F : $\pm 1\%$
ERG: Metal Oxide	50 : 1/2W	J : $\pm 5\%$
ERO: Metal Film	1A : 1W	
ERX: Metal Film	2A : 2W	

Capacitor Type	Voltage	Tolerance
ECEA : Electrolytic	OJ : 6.3V	J : $\pm 5\%$
ECEB : Electrolytic	1C : 16V	K : $\pm 5\%$
ECCD : Ceramic	1E : 25V	M : $\pm 20\%$
ECQM : Polyester	1H : 50V	Z : +80%, -20%
ECQU : Polyester	1 : 100V	
ECQF : Polyester	1A : 125V	
ECNC : Polyester	4A : 400V	

Ref. No.	Part No.	Value	Ref. No.	Part No.	Value	Ref. No.	Part No.	Value	Ref. No.	Part No.	Value
RESISTORS			R210	Ⓢ ERD25TJ183	18K	CAPACITORS			C210	Ⓢ ECQM1H224JZ	0.22
R1	Ⓢ ERD25FJ562	5.6K	R211	Ⓢ ERD25FJ472	4.7K	C1	ECEB1HU471	470	C211	Ⓢ ECQM1H473JZ	0.047
R2	Ⓢ ERD25FJ682	6.8K	R212	Ⓢ ERD25FJ151	150	C2	ECEA1EU330	33	C212	ECEA1HU3R3	3.3
R3	Ⓢ ERD25FJ272	2.7K	R213	Ⓢ ERD25FJ122	1.2K	C3	ECEA1EU220	22	C213	Ⓢ ECCD1H471K	470P
R4,5	Ⓢ ERD25FJ471	470	R214	Ⓢ ERD25TJ223	22K	C5,6	ECQM1223KZ	0.022	C214	ECEA1CU101	100
R101	Ⓢ ERD25FJ103	10K	R215	Ⓢ ERD25FJ472	4.7K	C101,102	ECEA1EU330	33	C215	ECEA1HU010	1
R102	Ⓢ ERX1ANJ4R7	4.7	R216	Ⓢ ERD25TJ154	150K	C103	ECEA1EU330	33	C216	ECEA1CU470	47
R103	Ⓢ ERD25FJ472	4.7K	R217	Ⓢ ERD25TJ223	22K	C104,105	Ⓢ ECQM1H104JZ	0.1	C217,218	ECKD1H104ZF	0.1
R104	Ⓢ ERD25TJ473	47K	R218	Ⓢ ERD25FJ102	1K	C106,107	Ⓢ ECQM1H104JZ	0.1	C219	ECKD1H104ZF	0.1
R105	Ⓢ ERD25FJ103	10K	R219	Ⓢ ERD25FJ332	3.3K	C108	ECEA1EU101	100	C301	ECQK1333GZ	0.033
R106	Ⓢ ERD25FJ150	15	R220	Ⓢ ERD25FJ221	220	C109,110	Ⓢ ECQM1H104JZ	0.1	C302	ECQK1682GZ	0.0068
R107	Ⓢ ERX1ANJ1R5	1.5	R221	Ⓢ ERD25FJ471	470	C111	Ⓢ ECQM1H562JZ	0.0056	C303	ECEA1HU010	1
R108	Ⓢ ERD25FJ103	10K	R222	Ⓢ ERD25FJ391	390	C112	ECEA1HU4R7	4.7	C304	ECEA1CU100	10
R109,110	Ⓢ ERX1ANJ4R7	4.7	R301	Ⓢ ER025CKF2701	2.7K	C201	ECEA1CU330	33	C305	Ⓢ ECQM1H122JZ	0.0012
R201	Ⓢ ERG1ANJ561	560	R302	Ⓢ ERD25FJ471	470	C202,203	ECEA1HU010	1	C306	ECEA1HU010	1
R202	Ⓢ ERD25FJ103	10K	R303	Ⓢ ERD25FJ822	8.2K	C204	Ⓢ ECQM1H473JZ	0.047	C601 [M]	Δ ECQF1A473MD	0.047
R203	Ⓢ ERD25FJ470	47	R304	Ⓢ ERD25FJ561	560	C205	ECEA0JU221	220	C601 [MC]	Δ ECQU1A47ME	0.047
R204	Ⓢ ERD25FJ272	2.7K	R305	Ⓢ ERD25FJ181	180	C206	ECEA1HU010	1	C601 [Other areas]	Δ ECNC4A473M	0.047
R205	Ⓢ ERD25TJ124	120K	R306	Ⓢ ERD25TJ223	22K	C207	Ⓢ ECCD1H101K	100P			
R206	Ⓢ ERD25TJ183	18K	R307	Ⓢ ERD25FJ272	2.7K	C208	Ⓢ ECCD1H220K	22P			
R207	Ⓢ ERD25TJ563	56K	R401	Δ Ⓢ ERD50FJ152	1.5K	C209	ECEA1CU101	100			
R208	Ⓢ ERD25TJ224	220K	R601	Δ Ⓢ ERD50FJ4R7	4.7						
R209	Ⓢ ERD25TJ334	330K									

REPLACEMENT PARTS LIST

- Notes:**
- Part numbers are indicated on most mechanical parts. Please use this part number for parts orders.
 - Important safety notice:
Components identified by Δ mark have special characteristics important for safety. When replacing any of these components use only manufacturer's specified parts.
 - Bracketed indications in Ref. No. columns specify the area. Parts without these indications can be used for all areas.
 - The "S" mark is service standard parts and may differ from production parts.
 - The parenthesized numbers in the column of description stand for the quantity per set.
 - \textcircled{K} -marked parts are used only for SL-1210MK2 (black type). And \textcircled{O} -marked parts are used for SL-1200MK2 (silver type).
 - Parts other than \textcircled{K} - and \textcircled{O} -marked are used for both SL-1210MK2 and SL-1200MK2.

Areas

- * [M] is available in the U.S.A.
- * [MC] is available in Canada.
- * [E] is available in Switzerland and Scandinavia.
- * [EK] is available in United Kingdom.
- * [XL] is available in Australia.
- * [EG] is available in F.R. Germany.
- * [EB] is available in Belgium.
- * [EH] is available in Holland.
- * [EF] is available in France.
- * [Ei] is available in Italy.
- * [XA] is available in Southeast Asia, Oceania, Africa, Middle Near East and Central South America.
- * [PA] is available in far East PX.
- * [PE] is available in European Military.
- * [PC] is available in European Audio Club.

Ref. No.	Part No.	Description	Ref. No.	Part No.	Description	Ref. No.	Part No.	Description
INTEGRATED CIRCUITS			CRYSTAL			LAMP		
IC101	AN6675	Turntable Drive	X201	SVQMS4193	4.193MHz Oscillator	PL1	Δ SFDN122-01	Stylus Illuminator
IC201	AN6680	Turntable Control	VARIABLE RESISTORS			TRANSFORMER		
IC301	AN6682	Pitch Control	VR201	\textcircled{S} EVTS3MA00B54	Brake Adjustment,50k Ω (\textcircled{B})	T1(M)	Δ SLT66DTL3A	Power Source
IC302	MN4011B	NAND Gate	VR301	EVMH1GA00B23	Pitch Control \pm 0% Adjustment,2k Ω (\textcircled{B})	T1(MC)	Δ SLT66DT14C	Power Source
TRANSISTORS			VR302	\textcircled{S} EVTS3MA00B54	Pitch Control Gain Adjustment,50k Ω (\textcircled{B})	T1(Other areas)	Δ SLT66DTE13E	Power Source
Q1	2SD1265	Regulator	VR303	SFDZ122N11	Pitch Control	FUSES		
Q2,3	2SD637	Regulator	SWITCHES			F1(MC)	Δ XBA1F12NU14	125V,1.2A
Q201	\textcircled{S} 2SC1846-R	Regulator	S201,202	EVQP5R04K	Speed Selector	F1 Except for (M,MC)	Δ XBA2C025T1A	250V,T250mA
Q202	2SD637	LED Driver	S203	SFDSS01GL13	Start/Stop	F2 Except for (M,MC)	Δ XBA2C10TR0	250V,T1A
Q203	\textcircled{S} 2SC1328-T	FG Amp.	S401	SFDS2MSL-C	Stylus-Illuminator			
DIODES			S601	Δ SFDSS5GL13P	Power			
D1	Δ SVDS1RBA20Z	Rectifier	S602 Except for (M,MC)	Δ SFDSHXW01317	Voltage Selector			
D2	MA1051	5.1V Zener						
D201,202	SVDPR3902S-9	Speed Indicator						
D203~206	SVDSLH54VT3	Strobe						
D204A	MA162A	Switching						
D301	MA1051	5.1V Zener						
D401	SVDGL-9NG2	Pitch Indicator						

SL-1200MK2/1210MK2

Ref. No.	Part No.	Description	Ref. No.	Part No.	Description	Ref. No.	Part No.	Description
CHABINET AND CHASSIS PARTS			TONEARM PARTS			ACCESSORIES		
1	SFAD122-01A	Dust Cover (1)	52	SFGC122-02E	Insulator (4)	N31	⊗ XWG3FZ	Washer (6)
2	SFTG172-01	Turntable Mat (1)	54	SFKT015-02E	Button, Speed (4)	N32	⊗ XSN3+14BVS	Screw (4)
3	SFTE172-01	Turntable Platter Ass'y (1)	55(M)	○ SFNN122M10,	Name Plate (1)	N33	⊗ XWA3BFZ	Washer (4)
4	SFUM172-05	Cover, Cabinet (1)	55(MC)	○ SFNN122C10	Name Plate (1)	N34	⊗ SFXG829-1	Screw (1)
5	SFMGQ20-01	Cover, Drive Coil (1)	55(E)	○ SFNN122S10	Name Plate (1)	N35	⊗ XSN3+8S	Screw (2)
6	SFMG520-31A	Drive Coil Ass'y (1)	55(EK,XL)	○ SFNN122G10	Name Plate (1)	N36	⊗ XUC5FT	Circlip (1)
7	SFMZ172-01E	FG Coil Ass'y (1)	55(XA)	○ SFNN122X10	Name Plate (1)	N37	⊗ SFPEV17202	Screw (3)
8	SFMZQ20-01A	Shaft Ass'y, Turntable (1)	55(PA,PE)	○ SFNN122P10	Name Plate (1)	N38	⊗ XTN3+25B	Screw (1)
10	○ SFAC122-01	Cabinet (Silver)	55(PC)	○ SFNN122P11	Name Plate (1)	N39	⊗ SFPEW1100	Washer (1)
10	⊗ SFAC124S01	Cabinet (Black)	55(Other areas)	○ SFNN122N10	Name Plate (1)	N40	⊗ XSN3+6BVS	Screw (4)
11	SFUM172-04	Ornament, Stylus Illuminator (1)	55(E)	⊗ SFNN124S10	Name Plate (1)	N41	⊗ XWC3BFZ	Washer (1)
12	SFKT122-01	Knob, Power Switch (1)	55	⊗ SFNN124Q10	Name Plate (1)	N42	⊗ XSN3+12BVS	Screw (2)
13	SFKK122-01E	Case, Strobe Illuminator (1)	[EG,EH]			N43	⊗ XWG3FZ	Washer (2)
14	SFKT015-06	Button, Start/Stop (1)	58	SFATM02N01A	Hinge (2)	N44	⊗ SFXW701-02	Washer (1)
15	SFOA122-01	Spring, Start/Stop Button (1)	59	SFUP122-25	Plate, Power transformer (1)	N45	⊗ SFPEW00705	Washer (4)
16	SFUM122-01	Base, Operation (1)	PACKING PARTS			N46	⊗ XTW26+5E	Screw (1)
17	SFKT015-01E	Button, Speed (1)	61	SFPC331001K	Headshell (1)	A1(M)	SFNU122M06	Instruction Book (1)
18	SFDJ122-02E	Connector, 7pin (1)	62	○ SFPAM18201K	Tonearm Ass'y (Silver) (1)	A1(MC)	SFNU122C06	Instruction Book (1)
19	SFGZ122-01	Spacer, Rubber (1)	62	⊗ SEPAM18202K	Tonearm Ass'y (Black) (1)	A1(E,EB,EC)	SFNU122S01	Instruction Book (1)
20	SFYB-5-32	Ball, Switch Cam (1)	63	SFPWG17201K	Balance Weight (1)	A1(EK)	SFNU122G01	Instruction Book (1)
21	SFOA520-01	Spring, Switch Cam (1)	64	SFPRT18201K	Lift Ass'y (1)	A1(PA, PE,PC)	SFNU122P01	Instruction Book (1)
22	SFUM122-03	Cam, Power Switch (1)	65	SFPZB17202	Knob, Arm Base Lock (1)	A1(Other areas)	SFNU122X01	Instruction Book (1)
23	SFUM015-11	Spacer, Speed Indicator(2)	66	SFQA829-03	Spring, Lift Ass'y (1)	A2	SFWE010	45 Adaptor (1)
24	SFKK172-01	Cover, Stylus Illuminator (1)	67	SFPAB13202	Knob, Arm Lift (1)	A3	SFPEN3302	Nut, Cartridge (2)
25	SFXB122-06	Boss, Drive (1)	68	SFPJL18202K	Oil Damper (1)	A4	SFPEW9601	Washer, Cartridge (2)
26	SFQA172-01	Spring, Drive Boss (1)	70	SFPZB12203	Plate, Arm Base Cover (1)	A5	SFCZV8801	Screw, Cartridge (2)
27	SFXJ172-01	Pin, Lock Canceler (1)	71	SFUM170-06	Spacer, Phono Cord (1)	A6	SFPEV9801	Screw, Cartridge (2)
28	SFUP122-02E	Bracket, Stylus Illuminator (1)	72	SEPZB12204	Clamper, Phono Cord (1)	A7	SFK0135-01	Overhang Gauge (1)
29	SFUP122-03	Plate, Lock Operation (1)	73	SFPAB18201K	Tonearm Fixing Plate (1)	A8	SFPZB3501	Shell Weight (1)
30	SFDJ122-03E	Connector, 3pin (1)	74	SFPZB12201K	Plate (1)	A9	SFDK119118	2pin Plug (1)
31	SFX0172-01	Pin, Guide (1)	75	SFDH122-05	Phono Cord (1)	[XA] Only		
32	SFOA520-01	Spring, Lock Canceler (1)	76	SFEL028-01E	Ground Wire (1)	A10	SFPWG17202	Sub-weight (1)
33	SFOA122-02	Spring, Lock Operation Plate (1)	77	SFPRT17201K	Arm Rest (1)	A11	⊗ QJP0603S	Adaptor, Gimens (1)
34	SFXJ172-05	Pin, Lock Operation Plate (1)	78	○ SFPKD17203	Arm Base (Silver) (1)	[PA,PE, PC] Only		
35(M,MC,PA PE,PC)	SFHK040L	Clamper, AC Cord (1)	78	⊗ SFPKD17205	Arm Base (Black) (1)			
35(EK)	SFSR-5N-4	Clamper, AC Cord (1)	79	SFPKB17204E	Ring, Arm Base Operation (1)			
35(Other areas)	SFSR-4N-4	Clamper, AC Cord (1)	80	SFPKD12201	Bracket, Arm Base (1)			
35(M,MC,PA PE,PC)	SFUP122-16	Bracket, AC Cord (1)	81	SFPAB17206	Knob, Anti-Skating (1)			
36(Other areas)	SFUP122X01	Bracket, AC Cord (1)	82	○ SFGK132-01	Cap (Silver) (1)			
37	⊗ △ SJA9Y	AC Cord (1)	82	⊗ SFGK133S01	Cap (Black) (1)			
37(M,MC)	QFC1205M	AC Cord (1)	SCREW,NUT AND WASHERS					
37(EK) ⊗ △	SJAG23	AC Cord (1)	N1	⊗ XTN3+8BFZ	Screw (5)			
37(XL) ⊗ △	SJA83	AC Cord (1)	N2	SFXGQ20-02	Screw (3)			
37 ⊗ △	SJA83	AC Cord (1)	N3	⊗ XTN3+8B	Screw (8)			
37 [PA,PE,PC]	SJA88	AC Cord (1)	N4	⊗ XWG3	Washer (12)			
37 ⊗ △	SJA88	AC Cord (1)	N5	⊗ XTN26+6B	Screw (3)			
37(Other areas)			N6	⊗ XTV3+8BFN	Screw (8)			
38	SFGC122-03	Rubber, Power Transformer (2)	N7	SFXG172-01	Screw (3)			
39	SFGC122-01	Cushion, Power Transformer (3)	N8	XTN3+5J	Screw (2)			
41	SFKT122-02	Knob, Pitch Control (1)	N9	SFXW172-03	Washer (1)			
42	○ SFKK122-03	Ornament (Silver), Pitch Control (1)	N10	SFPEW11003	Washer (6)			
42	⊗ SFKK124S01	Ornament (Black), Pitch Control (1)	N11	⊗ XWE3E10	Washer (3)			
43	SFUZ122-01	Felt (1)	N12	⊗ XWA3B	Washer (8)			
44	SFUP122-09	Holder, LED (1)	N13	⊗ XSN3+10S	Screw (3)			
45	SFUP122-01	Bracket, Pitch Control (1)	N14	SFXW910J02	Washer (1)			
46	SFDJ122-01E	Connector, 4pin (1)	N15	⊗ XTN3+10B	Screw (5)			
48	SFAU122-02	Bottom Base (1)	N16	⊗ XTN2+10B	Screw (1)			
48-1	SFAU122-03	Bottom Cover (1)	N17	⊗ XUC3FT	Circlip (2)			
49	SFUP122-23	Supporter (A), Hinge (2)	N18	⊗ XSN17+3FY	Screw (1)			
50	SFUP122-24	Supporter (B), Hinge (2)	N19	⊗ XUC2FT	Circlip (1)			
51	SFUMM02N04	Case, Hinge (2)	N20	⊗ XUC25FT	Circlip (1)			
			N21	⊗ XSN3+14S	Screw (1)			
			N22	RTW-12	Circlip (1)			
			N23	⊗ XSN2+10	Screw (2)			
			N24	⊗ XSN3+6S	Screw (2)			
			N25	⊗ XTN3+6B	Screw (5)			
			N26	XTWS3+14TFZ	Screw (6)			
			N27	SFXG122-02	Screw (11)			
			N29	SFXG122-01	Screw (4)			
			N30	XTN3+14QFZ	Screw (6)			

■ EXPLODED VIEWS
 • Cabinet and Chassis Parts

Note: For the set with serial number sheet change mark **E**, the power transformer is fitted as shown below.

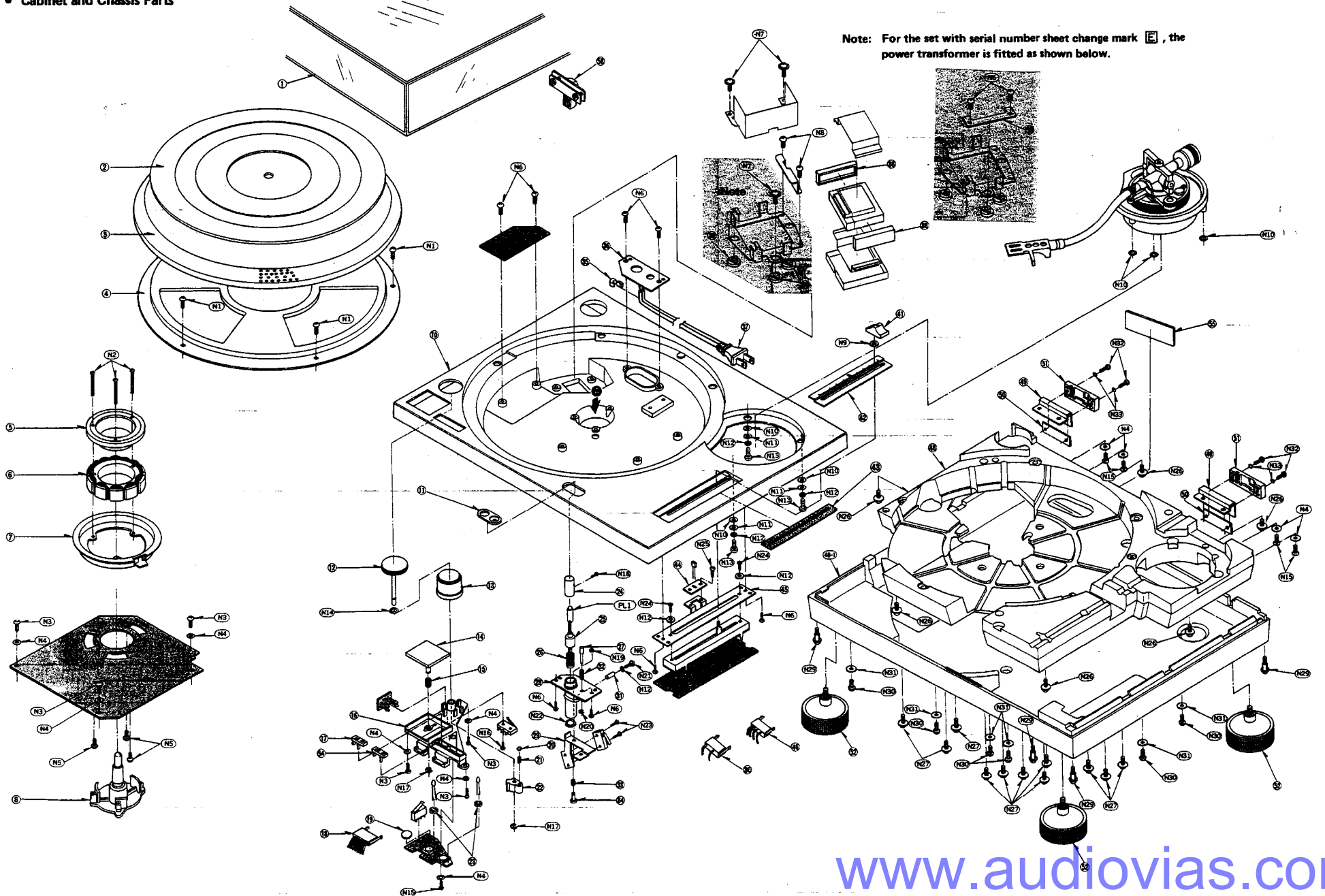

CIRCUIT BOARD AND WIRING CONNECTION DIAGRAM

- Power source circ
- * Product for Car

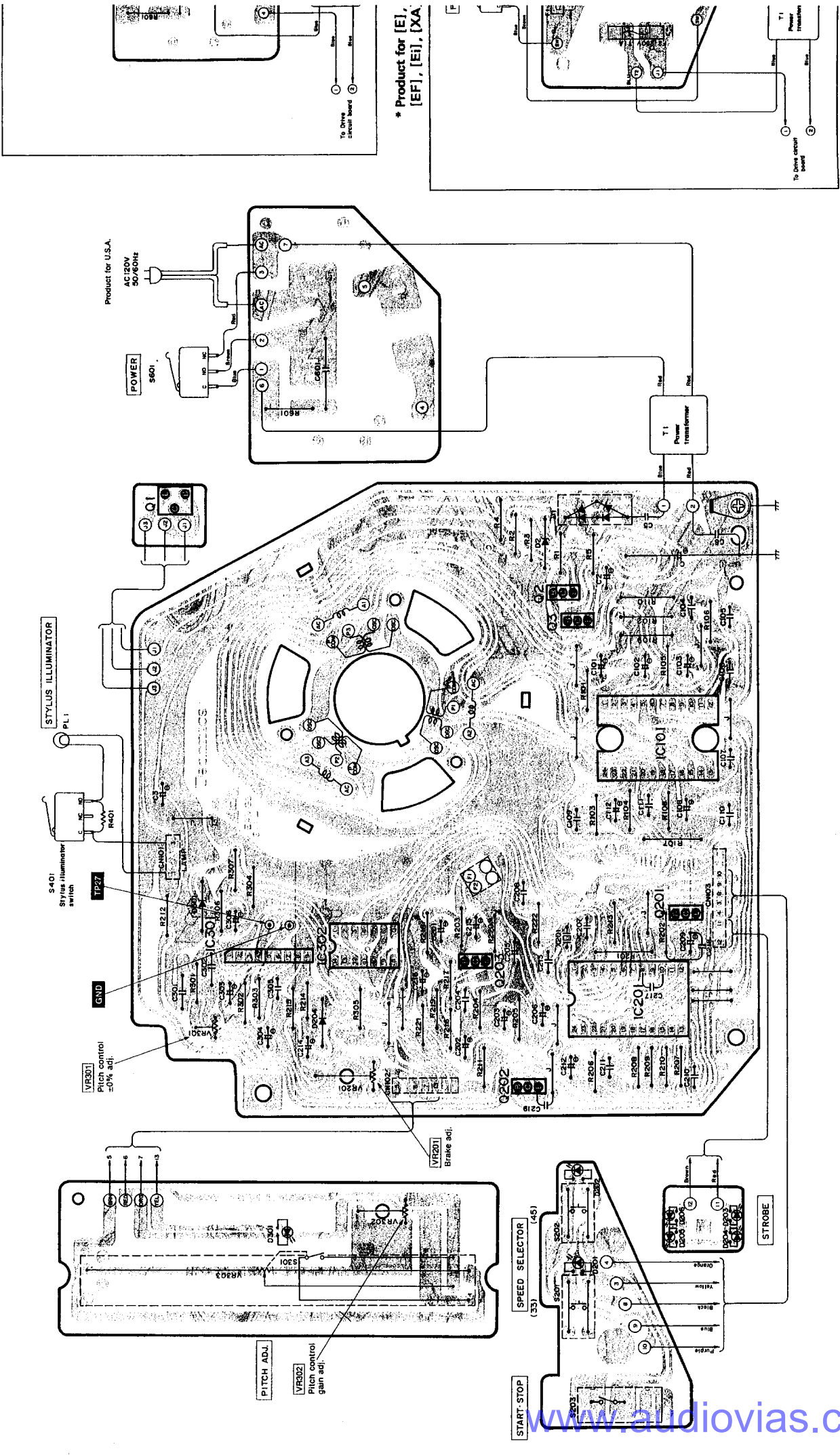

- Power source circuit
- * Product for Canada

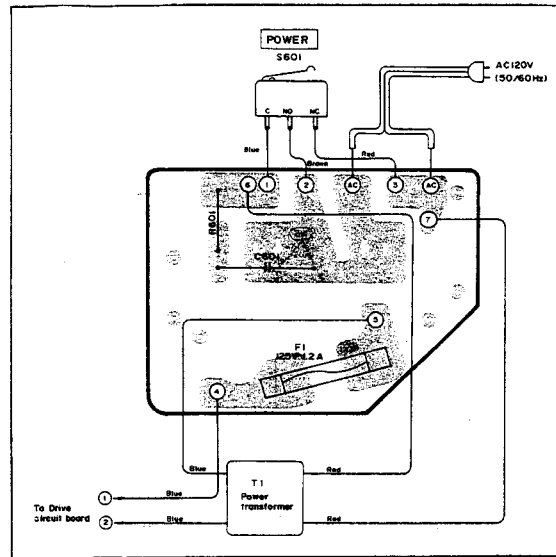
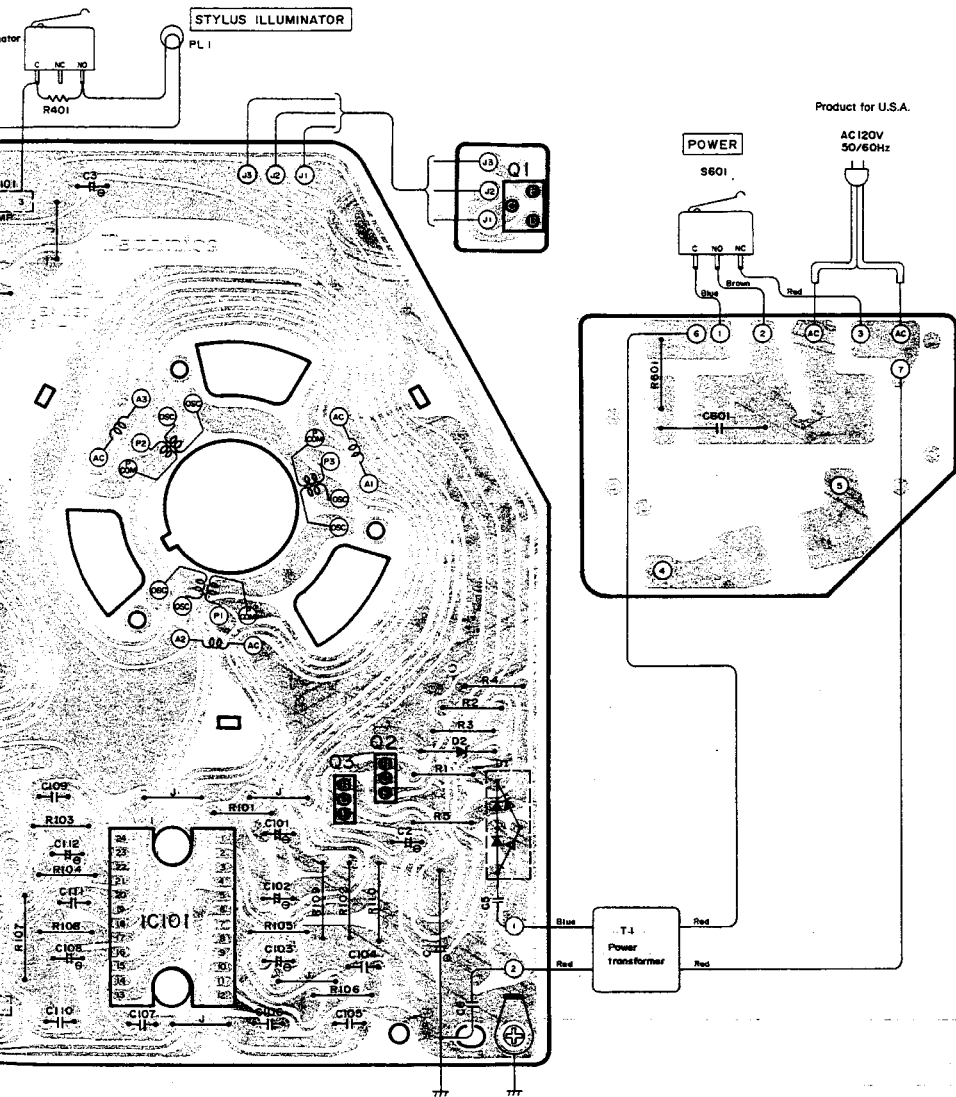

- * Product for [E], [EK], [XL], [EG], [EB], [EH], [EF], [Ei], [XA], [PA], [PE] and [PC] areas

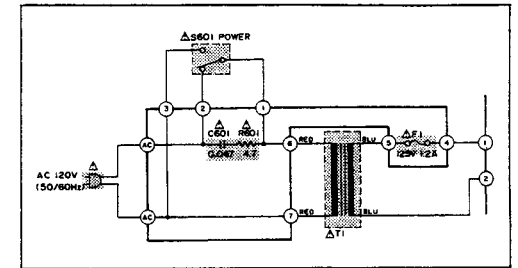
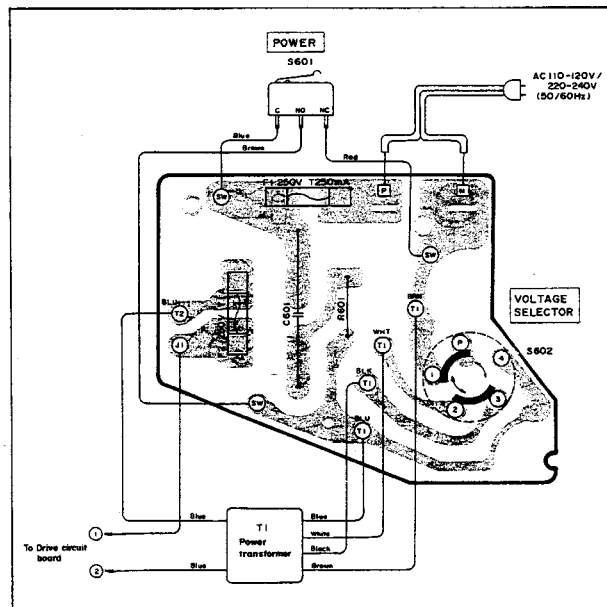

• Product for MC only

FUSE REPLACEMENT

 Symbol located near the fuse indicates fast operating type. For continued protection against fire hazard, replace with same type fuse. Refer to the symbol for fuse rating.

FUSIBLE REMPLACEMENT

 Le symbole qui se trouve près du fusible signifie un fusible à action rapide. Pour une protection continue contre les risques d'incendie, n'utiliser que des fusibles du même type. Se reporter au symbole pour la valeur des fusibles.

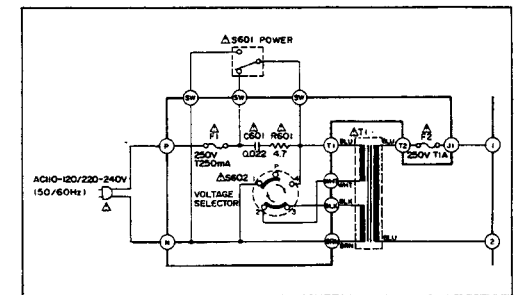

POWER SOURCE CIRCUIT

02,3 2SD637 REGULATOR
01 2SD1265 REGULATOR

01 SVDSIRBA20F RECTIFIER

D2 MA105IM 5.1V ZENER

0203 25C1328 FG AMP.

Product for U.S.A.

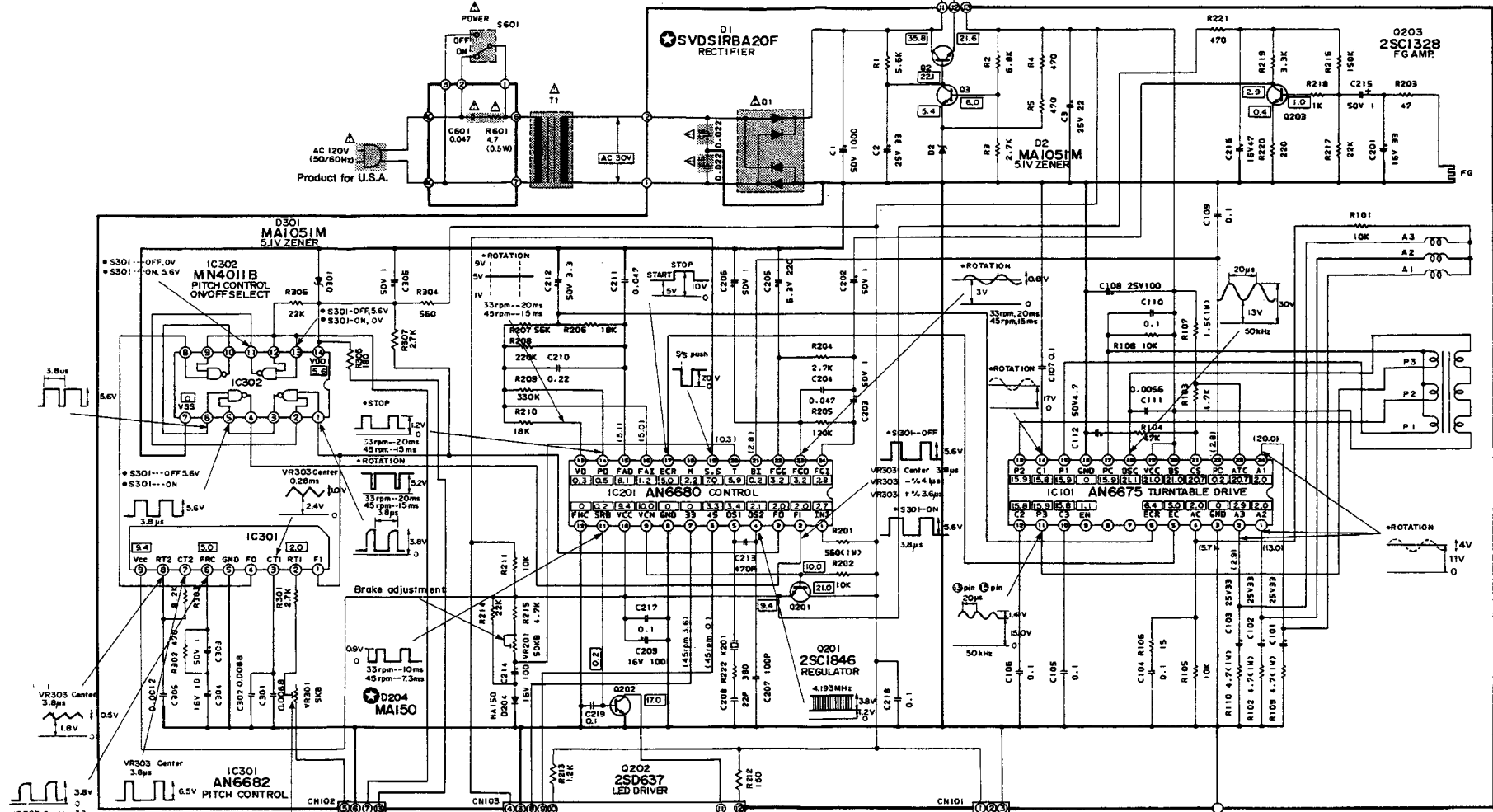

3.8µs
5.6V

3.8µs
5.6V

3.8µs
1.8V

3.8µs
6.5V

D301 MA105IM 5.1V ZENER

IC302 MN4011B PITCH CONTROL ON/OFF SELECT

IC301 AN6682 PITCH CONTROL

IC201 AN6680 CONTROL

D204 MA150

IC101 AN6675 TURNTABLE DRIVE

D401 SVDGL-9NG2 PITCH INDICATOR

IC302 MN4011B PITCH CONTROL ON/OFF SELECT

IC301 AN6682 PITCH CONTROL

IC201 AN6680 CONTROL

D204 MA150

IC101 AN6675 TURNTABLE DRIVE

D401 SVDGL-9NG2 PITCH INDICATOR

IC302 MN4011B PITCH CONTROL ON/OFF SELECT

IC301 AN6682 PITCH CONTROL

IC201 AN6680 CONTROL

D204 MA150

IC101 AN6675 TURNTABLE DRIVE

D401 SVDGL-9NG2 PITCH INDICATOR

IC302 MN4011B PITCH CONTROL ON/OFF SELECT

IC301 AN6682 PITCH CONTROL

IC201 AN6680 CONTROL

D204 MA150

IC101 AN6675 TURNTABLE DRIVE

D401 SVDGL-9NG2 PITCH INDICATOR

IC302 MN4011B PITCH CONTROL ON/OFF SELECT

IC301 AN6682 PITCH CONTROL

IC201 AN6680 CONTROL

D204 MA150

IC101 AN6675 TURNTABLE DRIVE

D401 SVDGL-9NG2 PITCH INDICATOR

IC302 MN4011B PITCH CONTROL ON/OFF SELECT

IC301 AN6682 PITCH CONTROL

IC201 AN6680 CONTROL

D204 MA150

IC101 AN6675 TURNTABLE DRIVE

D401 SVDGL-9NG2 PITCH INDICATOR

IC302 MN4011B PITCH CONTROL ON/OFF SELECT

IC301 AN6682 PITCH CONTROL

IC201 AN6680 CONTROL

D204 MA150

IC101 AN6675 TURNTABLE DRIVE

D401 SVDGL-9NG2 PITCH INDICATOR

IC302 MN4011B PITCH CONTROL ON/OFF SELECT

IC301 AN6682 PITCH CONTROL

IC201 AN6680 CONTROL

D204 MA150

IC101 AN6675 TURNTABLE DRIVE

D401 SVDGL-9NG2 PITCH INDICATOR

IC302 MN4011B PITCH CONTROL ON/OFF SELECT

IC301 AN6682 PITCH CONTROL

IC201 AN6680 CONTROL

D204 MA150

IC101 AN6675 TURNTABLE DRIVE

D401 SVDGL-9NG2 PITCH INDICATOR

IC302 MN4011B PITCH CONTROL ON/OFF SELECT

IC301 AN6682 PITCH CONTROL

IC201 AN6680 CONTROL

D204 MA150

IC101 AN6675 TURNTABLE DRIVE

D401 SVDGL-9NG2 PITCH INDICATOR

IC302 MN4011B PITCH CONTROL ON/OFF SELECT

IC301 AN6682 PITCH CONTROL

IC201 AN6680 CONTROL

D204 MA150

IC101 AN6675 TURNTABLE DRIVE

D401 SVDGL-9NG2 PITCH INDICATOR

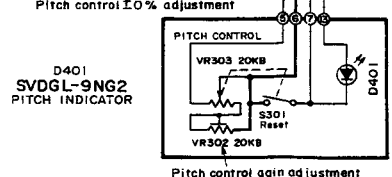

Pitch control ±0% adjustment

Pitch control gain adjustment

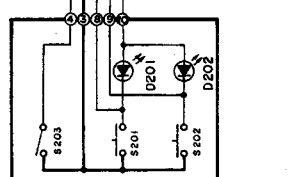

Pitch control gain adjustment

D201,202 SVDPR3902S-9 SPEED INDICATOR

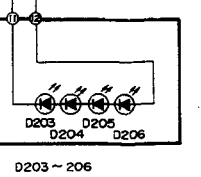

D203-206 SVDSLH54VT3 STROBE

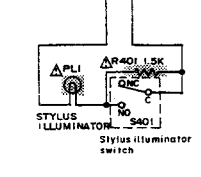

STYLUS ILLUMINATOR switch

■ BLOCK DIAGRAM

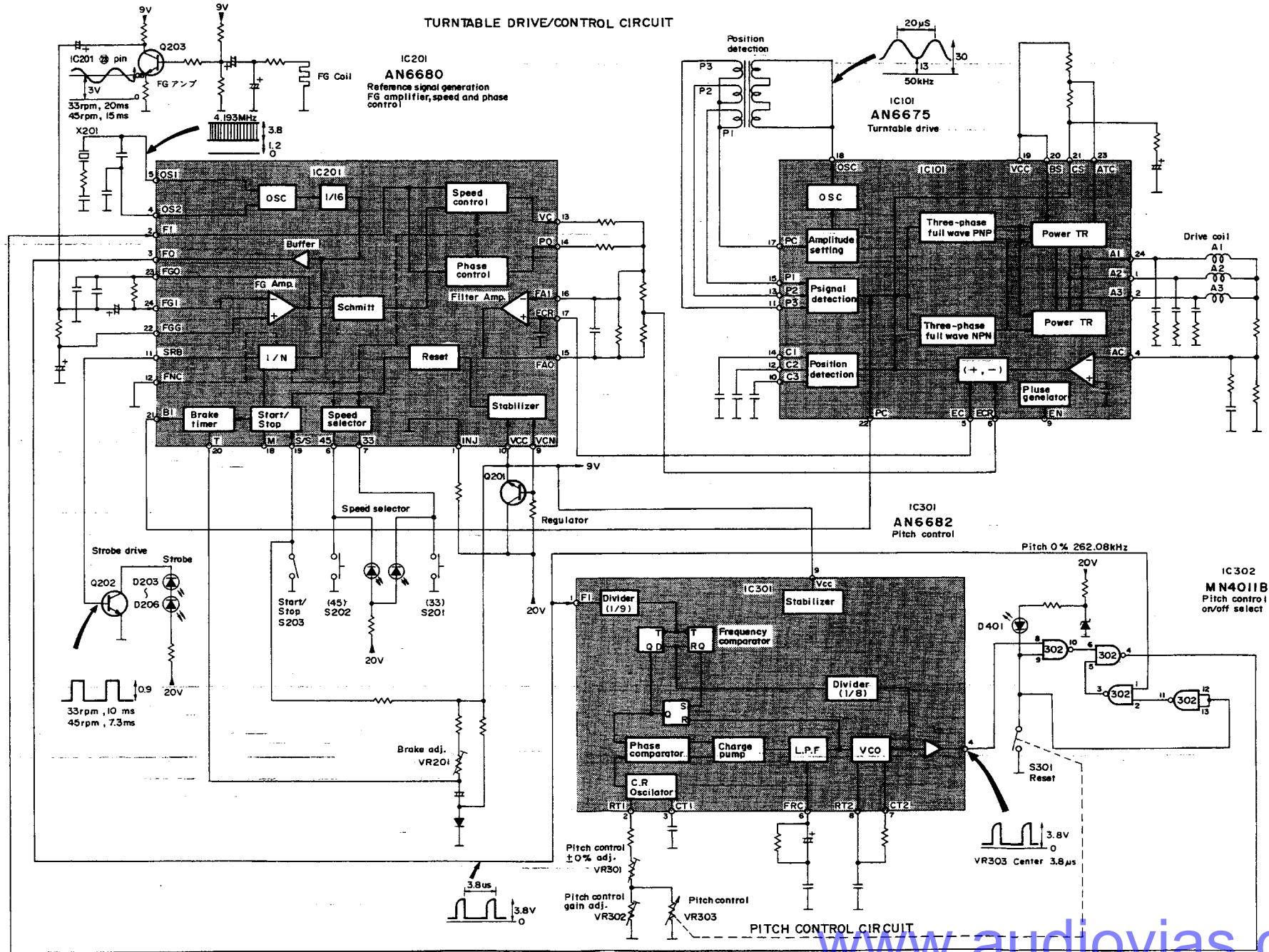

PACKING

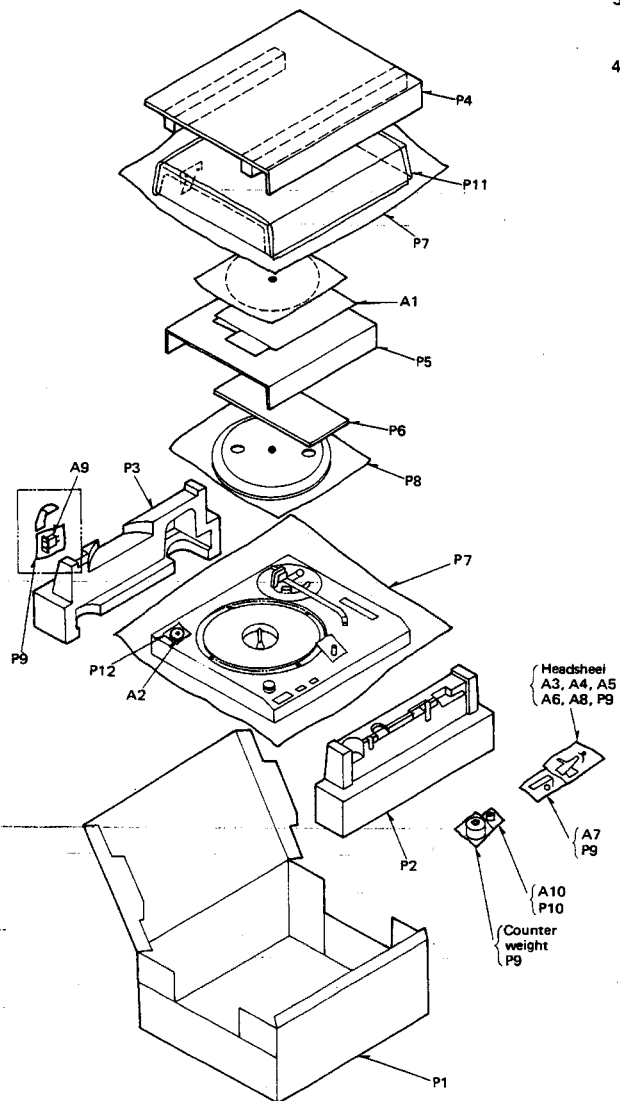

1. Place the unit (with cushions attached) as illustrated.
2. Fold the flaps according to the line marks.
3. Seal the top with adhesive tape.
 - * Use gum tape or adhesive cloth tape of 50mm wide at least
4. For the edges, first fold the flap "a" and then flap "b", and staple. Remember to staple only flap "b". (Use 15 or 16mm staple)

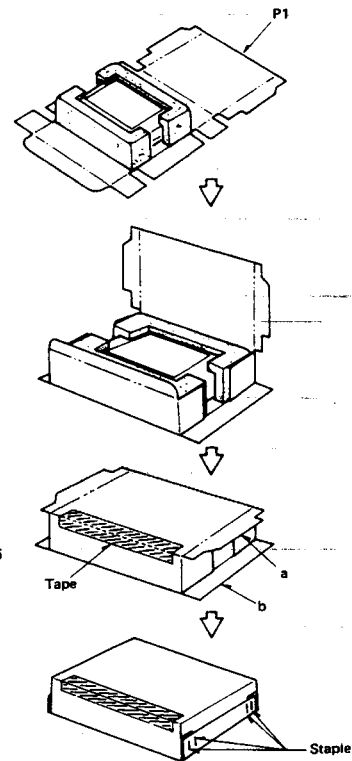

* Stapling positions are shown below.

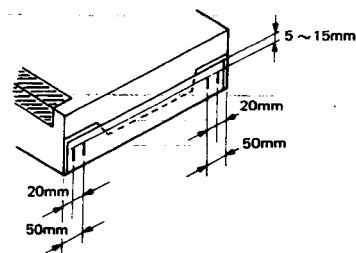

Service Manual

Turntable System

SL-1210MK2

[XG], [E]

Areas

- * [XG] is available in European.
- * [E] is available in Scandinavia.

For additional information, Please refer to the service manual for Model No. SL-1200MK2 [XG, XA, XGB, XAL, E]

- Notes:**
- * This service manual included only the change of the SL-1200MK2 [XG, XA, XGB, XAL, E] service manual (ORDER NO. SD7909-1622)
 - * When servicing model SL-1210MK2 [XG, E], this service manual and SL-1200MK2 (ORDER NO. 7909-1622) service manual should be used together.

CHANGES

REPLACEMENT PARTS LIST

Ref. No.	Change of Part No.		Part Name & Description	Per Set (Pcs.)	Remarks
	SL-1200MK2 [XG, XA, XGB, XAL, E]	→ SL-1210MK2 [XG, E]			
CABINET and CHASSIS PARTS					
10	SFAC122-01	SFAC124S01	Cabinet (Black)	1	○
35	SFSR4N4	SFSR4N4	Clamper, AC Cord	1	
	SFHK040L [XAL] only				
36	SFUP025X01	SFUP025X01	Blacket, AC Cord	1	
	SFUP025-01 [XAL] only				
37	RJA23ZC	SJA88	AC Cord	1	
	QFC1208M [XAL] only				
42	SFKK122-03	SFKK124S01	Ornament, Pitch Control Volume	1	
55	SFNN122N01	SFNN124Q01 [XG]	Name Plate	1	○
	SFNN122L01 [XAL] only				
	SFNN122S01 [E] only	SFNN124S01 [E]	Name Plate	1	○
— TONE ARM and ARM BASE PARTS					
62	SFPAM18201K	SFPAM18202K	Tone Arm Ass'y	1	○
82	SFGK132-01	SFGK133S01	Cap, Rubber	1	
PACKING PARTS					
P1	SFHP122M01	SFHP124S01	Carton Box	1	○

REPLACEMENT PARTS LIST (Mechanical)

- Notes: 1. Part numbers are indicated on most mechanical parts.
Please use this number for parts orders.
2. **△** indicates that only parts specified by manufacturer be used for safety.

Ref. No.	Part No.	Part Name & Description
CABINET and CHASSIS PARTS		
1	SFAD122-01A	Dust Cover
2	SFTG172-01	Turntable Mat
3	SFTE172-01Z	Turntable
4	SFUM172-05	Cover, Turntable
5	SFMGQ20-01	Cover, Stater Frame Ass'y
6	SFMG520-31A	Stater Frame
7	SFMZ172-01E	FG Detector Coil Ass'y
8	SFMZQ20-01A	Shaft, Stater Frame Ass'y
9	SFUP122-12	Plate, Shield
10	SFAC124S01	Cabinet
11	SFUM172-04	Ornament, Stylus-illuminator
12	SFKT122-01	Knob, Power Switch
13	SFKK122-01E	Case, Strobe-illuminator
14	SFKT015-06	Knob, Start/Stop Switch
15	SFQA122-01	Spring, Start/Stop Knob
16	SFUM122-01	Base, Operation
17	SFKT015-01E	Knob, Speed Selector (33-1/3 r.p.m.)
18	SFDJ122-02E	Connector; 7-PIN
19	SFGZ122-01	Spacer, Rubber (Speed Selector)
20	SFYB5-32	Ball, Switch Cam
21	SFQA520-01	Spring, Switch Cam
22	SFUM122-03	Cam, Switch
23	SFUM015-11	Spacer, LED
24	SFKK172-01	Cover, Lamp
25	SFXB122-02	Boss, Drive
26	SFQA172-01	Spring, Drive Boss
27	SFXJ172-01	Pin, Lock Canceler
28	SFUP122-02E	Bracket, Stylus-illuminator
29	SFUP122-03	Plate, Lock Operation
30	SFDJ122-03E	Connector, 3-PIN
31	SFXO172-01	Pin, Guide
32	SFQA520-01	Spring, Lock Canceler Pin
33	SFQA001-02	Spring, Lock Operating Plate M'tg
34	SFXJ172-05	Pin, Lock Operating Plate M'tg
35	SFSR4N4	Clamper, AC Cord
36	SFUP025X01	Bracket, AC Cord
37	△ SJA88	AC Cord
38	SFUP132-03	Bracket, Power Transformer
39	SFGC122-01	Cushion, Power Transformer
40	SFUP122-10	Spacer, Power Transformer
41	SFKT122-02	Knob, Pitch Control Volume
42	SFKK124S01	Ornament, Pitch Control Volume
43	SFUZ122-01	Shading Cloth, Pitch Control Volume
44	SFUP122-09	Holder, LED
45	SFUP122-01	Bracket, Pitch Control Volume
46	SFDJ122-01E	Connector, 4-PIN
47	SFUP122-13	Supporter, Bottom Base
48	SFAU122-01	Base, Bottom
49	SFUP122-05	Supporter (A), Hinge
50	SFUP122-04	Supporter (B), Hinge
51	SFUM170-07	Case, Hinge
52	SFGC122-02E	Audio Insulator
53	SFUP122-06	Supporter (C), Hinge
54	SFKT015-02E	Knob, Speed Selector (45 r.p.m.)
55 [XG]	SFNN124Q01	Name Plate
55 [E]	SFNN124S01	Name Plate
56	SFXO122-01	Pipe (A)
57	SFXO122-02	Pipe (B)
58	SFAT122-01A	Hinge Ass'y
STONE ARM and ARM BASE		
61	SFPCC31001K	Head Shell
62	SFPAM18202K	Tone Arm Ass'y
63	SFPWG17201K	Balance Weight Ass'y
64	SFPRT18201K	Lift Ass'y
65	SFPZB17202	Knob, Arm Base Lock
66	SFQA829-03	Spring, Lift Ass'y
67	SFPAB13202	Knob, Arm Lift
68	SFPJL18202K	Oil Damper
70	SFPZB12203	Plate, Arm Base Cover
71	SFUM170-06	Spacer, Phono Cord
72	SFPZB12204	Clamper, Phono Cord
73	SFPAB18201K	Tone Arm Fixing Plate Ass'y

Ref. No.	Part No.	Part Name & Description
74	SFPZB12201K	Plate, Position Fix
75	SFDH028-01	Phono Cord
76	SFELQ28-01E	Ground Wire
77	SFPRT17201K	Arm Rest
78	SFPKD17203	Arm Base
79	SFPKB17201S	Ring, Arm Base Operation
80	SFPKD12201	Bracket, Arm Base
81	SFPAB17206	Knob, Anti-skate Force Control
82	SFGK133S01	Cap, Rubber
SCREWS, WASHERS and CIRCLIPS		
●	XTN3+8BFZ	Screw
●	SFXGQ20-02	Screw
●	XTN3+8B	Screw
●	XTN26+6B	Screw
●	XTN4+10B	Screw
●	XWA4B	Washer
●	XUC3FT	Circlip
●	XUC2FT	Circlip
●	XUC25FT	Circlip
●	SFXW910J02	Washer
●	XTN3+40BFZ	Screw
●	XSN3+10BVS	Screw
●	XWE3F12FZ	Washer
●	XTN3+25BFZ	Screw
●	SFXW122-01	Washer
●	XWE3E10	Washer
●	SFPEW1100	Washer
●	SFPEW11003	Washer
●	XSN3+8S	Screw
●	SFXG172-01	Screw
●	XTV3+8BFN	Screw
●	XTN3+10B	Screw
●	XTN2+10B	Screw
●	XSN17+3FY	Screw
●	XSN3+14S	Screw
●	SFXW172-04	Washer
●	XUB14FT	Circlip
●	SFUZ172-05	O Ring
●	XTN3+6B	Screw
●	XSN3+6S	Screw
●	XWA3BFZ	Washer
●	XWA3B	Washer
●	XWG3	Washer
●	SFXG829-1	Screw
●	XUC5FT	Circlip
●	XTW3+6B	Screw
●	XTV3+6BFN	Screw
●	XWE4A10EW	Washer
●	XTN3+25B	Screw
●	XYN3+C6FZS	Screw
●	XSN3+12BVS	Screw
●	SFPEW17201	Washer
●	XWG26	Washer
ACCESSORIES		
A1 [XG]	SFNU122X01	Instruction Book
A1 [E]	SFNU122S01	Instruction Book
A2	SFWE010	Adaptor, 45 r.p.m.
A3	SFPEN3302	Nut, Cartridge
A4	SFPEW9601	Washer, Cartridge
A5	SFCZV8801	Screw, Cartridge
A6	SFPEV9801	Screw, Cartridge
A7	SFKO135-01	Overhang Gauge
A8	SFPZB3501	Shell Weight
PACKINGS		
P1	SFHP124S01	Carton
P2	SFHH122-01	Pad, Front
P3	SFHH122-02	Pad, Rear
P4	SFHD122-01	Pad, Top
P5	SFHD122-02	Pad, (A), Turntable
P6	SFHD122-03	Pad, (B), Turntable
P7	SFYH60X60	Polyethylene Cover, Turntable Unit and Dust Cover
P8	SFYH40X45	Polyethylene Cover, Turntable

Service Manual

SL-1200MK2



Turntable System SL-1200MK2 (XG), (XA), (XGB) (XAL), (E)

- * The model SL-1200MK2 (XG) is available in European only.
- * The model SL-1200MK2 (XA) is available in Asia, Latin America, Middle East and Africa only.
- * The model SL-1200MK2 (XGB) is available in Belgium only.
- * The model SL-1200MK2 (XAL) is available in Australia only.
- * The model SL-1200MK2 (E) is available in Scandinavia only.

SPECIFICATIONS (Specifications subject to change without notice. Weight and dimensions shown are approximate.)

General

Power supply: ~110-120/220-240, 50 or 60 Hz
Power consumption: 13.5 W
Dimensions: 45.3 x 16.2 x 36 cm
 (W x H x D) (17-27/32" x 6-19/64" x 14-11/64")
Weight: 12.5 kg (27.6 lb)

Turntable section

Type: Quartz direct drive
 Manual turntable
Drive method: Direct drive
Motor: Brushless DC motor
Turntable platter: Aluminum diecast
 Diameter 33.2 cm (13-5/64")
 Weight 2 kg (4.4 lb)
Turntable speeds: 33-1/3 rpm and 45 rpm
Starting torque: 1.5 kg.cm (1.3 lb.in)
Build-up characteristics: 0.7 s. from standstill to 33-1/3 rpm
Braking system: Electronic brake
Wow and flutter: 0.01% WRMS*
 0.025% WRMS (JIS C5521)
 ±0.035% peak (IEC 98A Weighted)

* This rating refers to turntable assembly alone, excluding effects of record, cartridge or tonearm, but including platter. Measured by obtaining signal from built-in frequency generator of motor assembly.

Rumble: -56 dB (IEC 98A Unweighted)
 -78 dB (IEC 98A Weighted)

Tonearm section

Type: Universal
Effective length: 230 mm (9-1/16")
Arm height adjustment range: 0-6 mm
Overhang: 15 mm (19/32")

Effective mass: 12-g (without cartridge)
Offset angle: 22°
Friction: Less than 7 mg (lateral, vertical)
Tracking error angle: Within 2°32' (at the outer groove of 30 cm (12") record)
Stylus pressure adjustment range: Within 0°32' (at the inner groove of 30 cm (12") record)
 0-2.5 g
Applicable cartridge weight range: 6-10 g
 13.5-17.5 g (including headshell)
(with auxiliary weight): 9.5-13 g
 17-20.5 g (including headshell)
(with shell weight) 3.5-6.5 g
 11-14 g (including headshell)
Headshell weight: 7.5 g

Cartridge section

Model No. EPC-207C
Type: Moving magnet
Frequency response: 20 Hz to 25 kHz
 20 Hz to 15 kHz ±2 dB
Output voltage: 3 mV at 1 kHz
 5 cm/s. zero to peak lateral velocity
 [8.5 mV at 1 kHz 10 cm/s. zero to peak 45° velocity (DIN 45500)]
Channel separation: 25 dB at 1 kHz
Channel balance: Within 2 dB at 1 kHz
Compliance (dynamic): 10 x 10⁶ cm/dyne at 100Hz
Stylus pressure: 1.75 ±0.25 g (17.5 ±2.5 mN)
Load impedance: 47 kΩ to 100 kΩ
Weight: 5.6 g (cartridge only)
Replacement stylus: EPS-207ED
 (Elliptical stylus)

TECHNISCHE DATEN

Allgemeine Daten

Stromversorgung: ~110-120/220-240 V, 50/60 Hz Wechselstrom

Leistungsaufnahme: 13,5 W

Abmessungen (B x H x T): 45,3 x 16,2 x 36 cm

Gewicht: 12,5 kg

Plattenspieler

Typ: Manueller Quarz-Direktantrieb Plattenspieler

Antrieb: Direktantrieb

Motor: Kollektorloser Gleichstrommotor

Plattenteller: Aluminium-Spritzguß

Durchmesser 33,2 cm

Gewicht 2 kg

Plattenteller-Drehzahlen: 33-1/3 und 45 U/min

Anlaufdrehmoment: 0,7 sec vom Stillstand auf 33-1/3 U/min

Bremssystem: Elektronische Bremse

Gleichlaufschwankungen: 0,01% WRMS*
0,25% WRMS (JIS C5521)
±0,035% Spitze (IEC 98A bewertet)

Diese Nennleistung bezieht sich auf das Laufwerk-Bauteil allein, ausschließlich Einflüsse von Schallplatte, Tonabnehmer oder Tonarm, aber einschließlich Plattenteller. Gemessen anhand von Signalen vom eingebauten Frequenzgenerator des Motorbauteils.

Rumpel-Geräuschspannungsabstand: -56 dB (IEC 98A unbewertet)
-78 dB (IEC 98A bewertet)

Tonarm

Typ: Universal-Tonarm

Effektive Länge: 230 mm

Tonarmhöhe-Einstellbereich: 0-6 mm

Überhang: 15 mm

Effektive Masse: 12 g (ohne Tonabnehmer)

Kröpfungswinkel: 22°
Lagerreibung: Weniger als 7 mg (horizontal, vertikal)

Auflagekraft-Einstellbereich: 0-2,5 g

Zulässiger Ton-abnehmer-Gewichtsbereich: 6-10 g
13,5-17 g (einschließlich Tonarmkopf)

9,5-13 g
(mit Zusatz-Gegengewicht): 17-20,5 g (einschließlich Tonarmkopf)

Gewichtsbereich: 3,5-6,5 g
(mit Zusatzgewicht) 11-14 g (einschließlich Tonarmkopf)

Tonarmkopf-Gewicht: 7,5 g

Tonabnehmer

Modell-Nummer: EPC-207C

Typ: Magnetischer Tonabnehmer

Frequenzgang: 20 Hz bis 25 kHz

20 Hz bis 15 kHz ±2 dB

Ausgangsspannung: 3 mV bei 1 kHz

5 cm/s, Null-zu-Spitze, lateral

[8,5 mV bei 1 kHz 10 cm/s, Null-zu-

Spitze, 45° (DIN 45500)]

Kanaltrennung: 25 dB bei 1 kHz

Kanalabweichung: Innerhalb 2 dB bei 1 kHz

Nachgiebigkeit (dynamisch): 10 x 10⁶ cm/dyn bei 100 Hz

Auflagekraft: 1,75 ±0,25 g (1,75 ±2,5 mN)

Impedanz: 47 kΩ bis 100 kΩ

Gewicht: 5,6 g (ohne Tonarmkopf)

Ersatznadel: EPS-207ED
(Elliptische Nadel)

Änderungen der technischen Daten vorbehalten.
Die angegebenen Gewichts- und Abmessungsdaten sind ungefähre Werte.

SPECIFICATIONS

Généralités

Alimentation: Alternatif 110-120/220-240V, 50 ou 60 Hz

Consommation: 13,5W

(L x H x P)

Poids: 12,5 kg

Platine de lecture

Typ: Entaînement direct à quartz
Platine manuelle

Système d'entraînement: Entraînement direct

Moteur: Moteur C.C. sans balai

Plateau de lecture: Aluminium moulé sous pression

Diamètre 33,2 cm

Poids 2 kg

Vitesses de rotation: 33-1/3 et 45 t/p.m

Couple de démarrage: 1,5 kg.cm

Caractéristiques d'augmentation: 0,7 s (rotation de 90°) à
33-1/3 t/p.m.

Système de freinage: Frein électronique

Pleurage et scintillement: 0,01% de valeur efficace*
0,025% de valeur efficace (JIS C5521)
±0,035% de crête (IEC 98A Pondéré)

* Ce régime nominal se rapporte à l'ensemble du tournedisqueseul, excluant les effets du disque, de la cellule pick-up ou de bras de lecture, mais comprenant le plateau. Mesuré par l'obtention d'un signal provenant du générateur de fréquences incorporé de l'ensemble du moteur.

Ronflement: -56 dB (IEC 98A Non pondéré)
-78dB (IEC 98A Pondéré)

Bras de lecture

Typ: Bras de lecture universel

Longueur effective: 230 mm

Portée du réglage de la hauteur du bras: 0-6 mm

Porte-à-faux: 15 mm

Masse réelle: 12 g (sans la cellule pick-up)

Angle d'erreur de piste: En deçà de 2°32' au sillon extérieur
d'un disque de 30 cm

En deçà de 0°32' au sillon intérieur
d'un disque de 30 cm

Angle de décalage: 22°

Frottement: Moins de 7 mg (latéral et vertical)

Plage de réglage de la pression d'appui: 0-2,5 g

Gamme du poids de la cellule pick-up utilisable: 6-10 g
13,5-17,5 g
(y compris la coque porte-cellule)

(avec contrepoids auxiliaire) 9,5-13 g
17-20,5 g
(y compris la coque porte-cellule)

(avec contrepoids de la cellule) 3,5-6,5 g
11-14 g
(y compris la coque porte-cellule)

Poids de la cellule: 7,5 g

Cellule pick-up

No. du modèle: EPC-207C

Type: Aimant mobile

Réponse en fréquence: 20 Hz à 25 kHz

20 Hz à 15 kHz ±2dB

Tension de sortie: 3 mV à 1 kHz; 5 cm/s, zéro à
vitesse latérale de crête

(8,5 mV à 1 kHz 10 cm/s., zéro à
vitesse 45° de crête [DIN 45500])

25 dB à 1 kHz

Séparation de canal: En deçà de 2 dB à 1 kHz

Equilibrage des canaux: 10 x 10⁶ cm/dyne à 100 Hz

Elasticité (dynamique): 1,75 ±0,25 g (1,75 ±2,5 mN)

Pression de la pointe de lecture: 47 kΩ to 100 kΩ

Impédance de charge: 5,6 grammes (cellule seule)

Poids: EPS-207ED
(Forme elliptique)

Les spécifications sont susceptibles d'être modifiées sans préavis.
Les poids et les dimensions donnés sont approximatifs.

CONTENTS

DISASSEMBLY PROCEDURE 3, 4
 PARTS IDENTIFICATIONS 4
 ARM BASE ASSEMBLING PROCEDURE 5
 ADJUSTMENTS 6-8
 SCHEMATIC DIAGRAM 9, 10
 REPLACEMENT PARTS LIST (Electrical) 11
 TROUBLE SHOOTING 12
 PRINTED CIRCUIT BOARD 13, 14
 BLOCK DIAGRAM 15, 16

ADJUSTMENTS (Electrical) 17
 REFERENCE VOLTAGE AND WAVEFORM AT EACH IC PIN 17, 18
 EXPLODED VIEWS 19, 20, 22
 REPLACEMENT PARTS LIST (Mechanical) 21
 FEATURES 23

DISASSEMBLY PROCEDURE

How to remove panel cover

1. Remove head shell and turntable.
2. Secure arm with arm clamp.
3. Remove 5 screws **A** of the panel cover as shown in Fig. 1.

How to remove stater frame coil and F.G detector coil

4. Remove 3 connectors **B** and 2 read wires **C** from power transformer as shown in Fig. 2.
5. Remove 3 screws **D** of the drive circuit board and 3 screws **E** of the stater frame cover as shown in Fig. 2.
6. Disconnect 18 soldered parts **F** of the stater coil and 4 soldered parts **G** of the F.G detector coil as show in Fig. 3.
7. Remove 3 screws **H** of the stater frame ass'y as shown in Fig. 3.

How to remove bottom base ass'y

8. Remove 4 audio insulators. (Counterclockwise rotation)
9. Remove 17 screws and spacer **I** as show in Fig. 4.
10. Remove 11 screws **J** as shown in Fig. 4.

How to remove stylus-illuminator lamp

11. Remove 2 screws **K** of the stylus-illuminator lamp ass'y as shown in Fig. 5.
12. Remove 1 screw **L** as shown in Fig. 6.

How to remove neon-illuminator L.E.D.

13. Remove 4 screws **M** as shown in Fig. 5.
14. Remove 1 circlip **N** and switch cam **O** as shown in Fig. 5.
15. Remove strobo-illuminator case.

How to remove tone arm

16. Remove 4 screws **P** of the arm base cover as shown in Fig. 5.
17. Remove 2 screws **Q** of the phono cord clamper as shown in Fig. 5.
18. Remove phono cord clamper as shown in Fig. 7.
19. Remove 2 screws **R** of the phono cord p.c.b. as shown in Fig. 8.
20. Remove 2 screws **S** as shown in Fig. 8.
21. Remove 2 screws **T** of the silicon oil dumper as shown in Fig. 8.
22. Remove 3 screws **U** as shown in Fig. 8.
23. Remove 2 screws **X** of the tone arm as shown in Fig. 9.

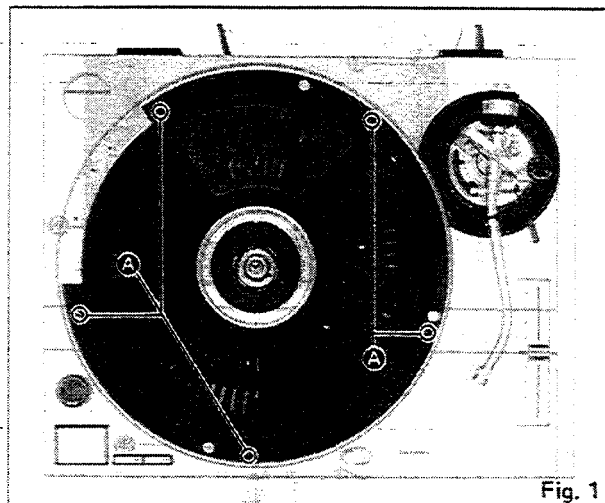

Fig. 1

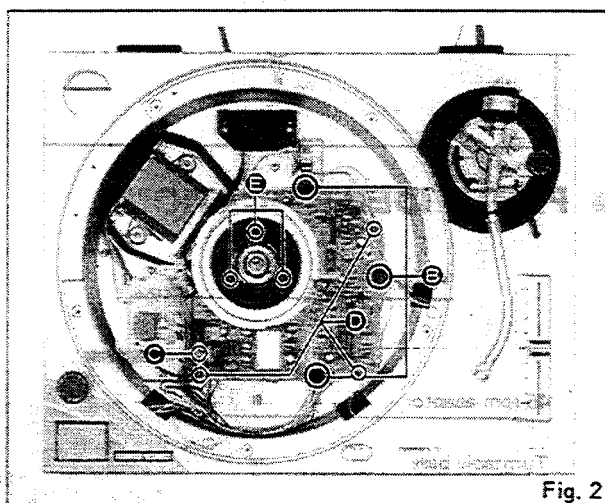

Fig. 2

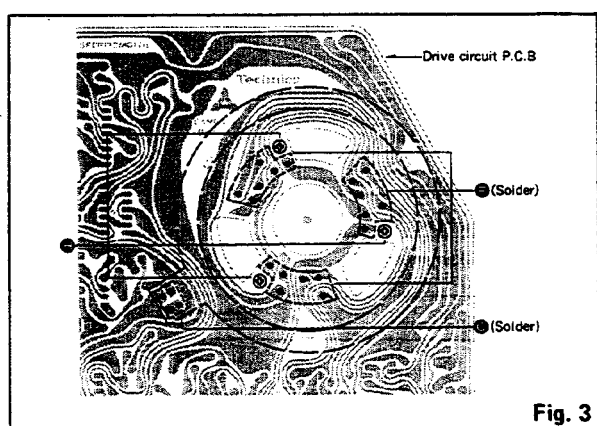

Fig. 3

SL-1200MK2

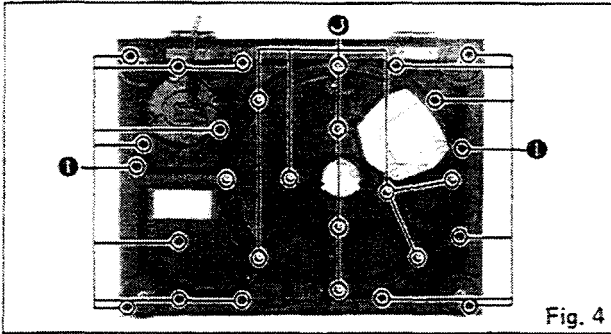

Fig. 4

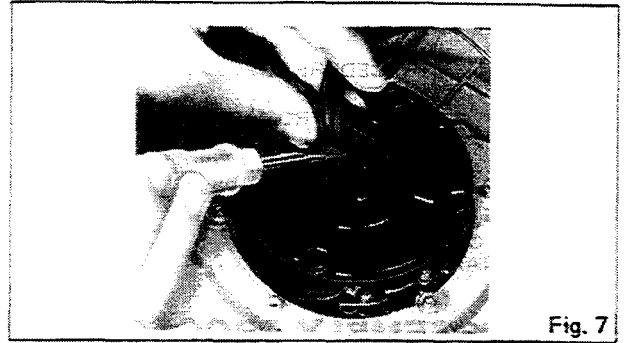

Fig. 7

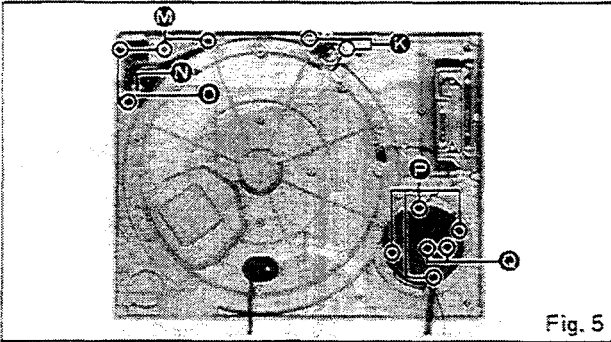

Fig. 5

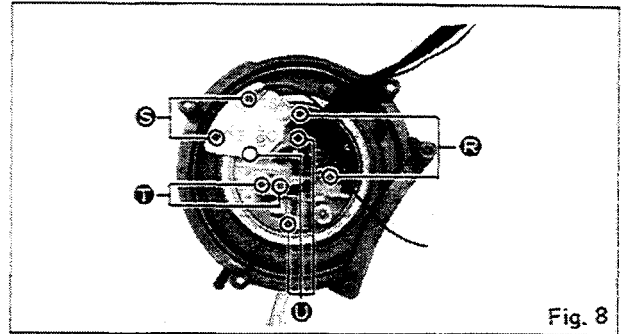

Fig. 8

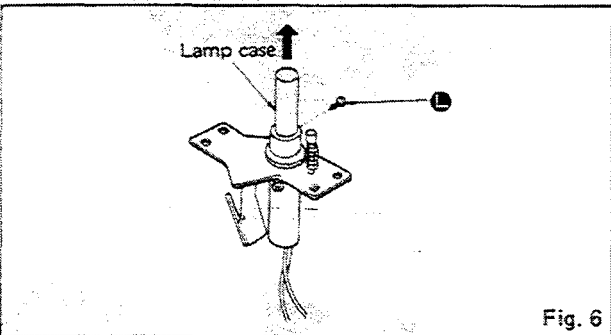

Fig. 6

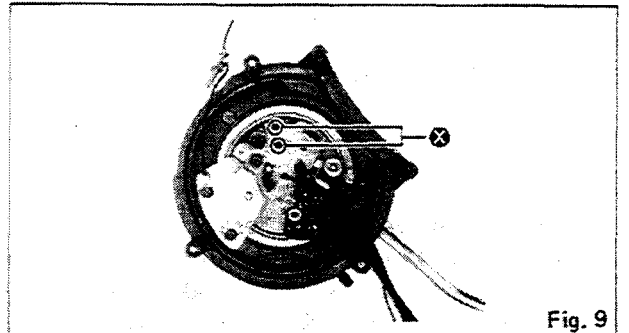

Fig. 9

■ PARTS IDENTIFICATION

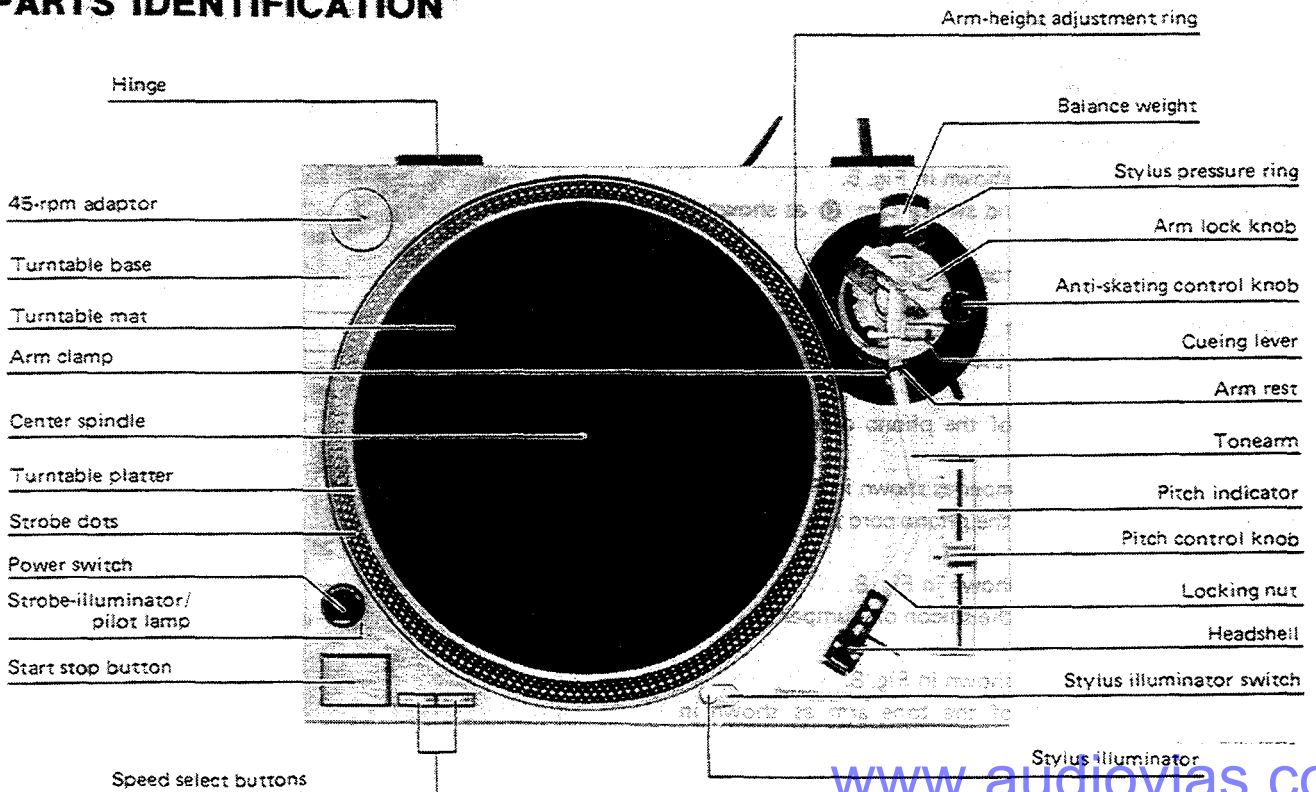

Fig. 10

■ ARM BASE ASSEMBLING PROCEDURE

1. Attach the control ring to the arm base seat. (The control ring should be rotated counterclockwise.)
2. Completely tighten the control ring, and then loosen it 1.5~2.5 turns to set the scale to "3". (See Fig. 11)

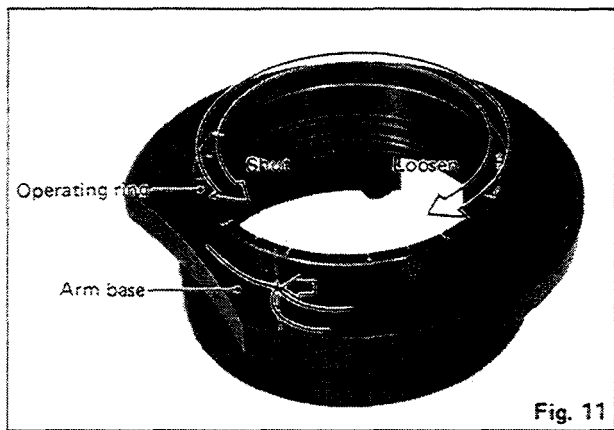

Fig. 11

3. Hold the arm base and set the red line mark on the arm base to the scale near "2", then turn the arm base clockwise. (See Fig. 12)

Note:

Take care not to allow deflection of the predetermined positions of the control-ring and arm base seat.

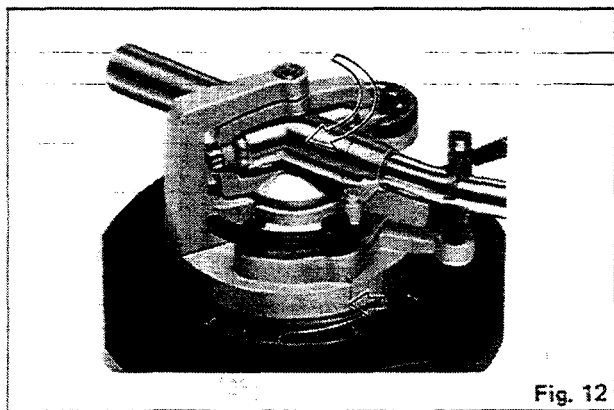

Fig. 12

4. Adjust the arm base so that the red line mark on the arm base is set to the scale "3" of the control ring. Next, secure the positioning base plate with two setscrews. (See Fig. 13)

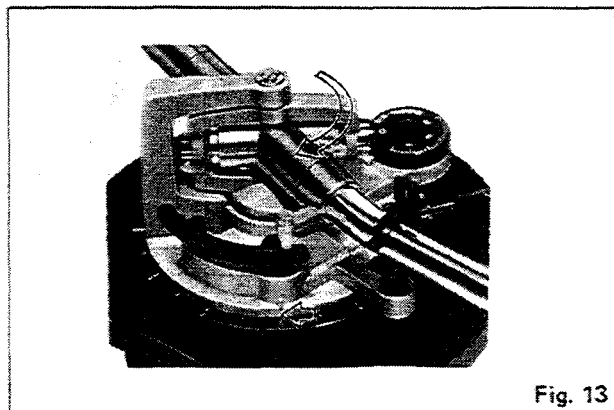

Fig. 13

5. Rotate the control ring and make sure that the arm base shifts within the range of 0~6mm. (See Figs. 14 and 15) If it does not shift within the specified range, the arm base position is deflected. In that case, disassemble the parts and check as specified in step 3.

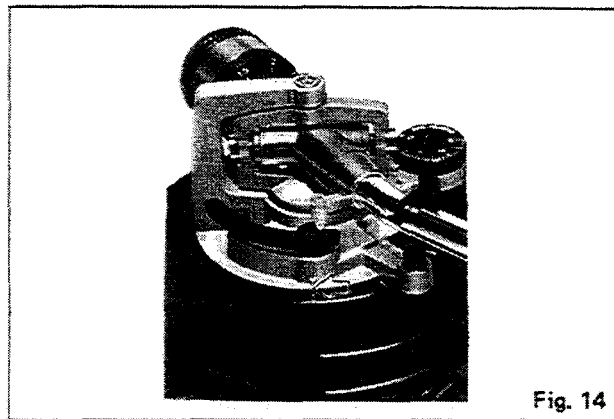

Fig. 14

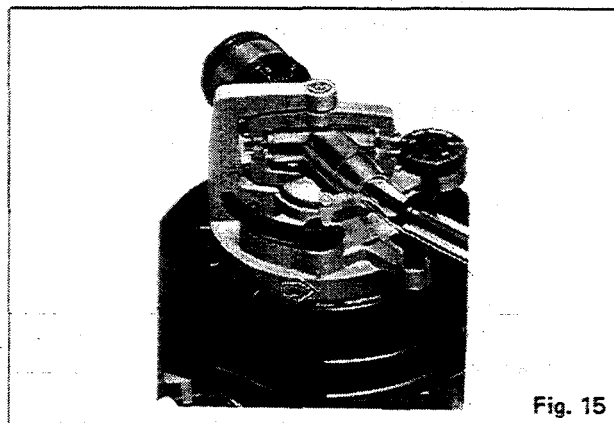

Fig. 15

■ ADJUSTMENT OF CANCELLER SPRING POSITION

If the arm body or PU base plate is replaced, be sure to set the canceller knob to "0.5" and make sure that the canceller spring is in contact with the arm shaft. (See Fig. 16) If the canceller spring is deflected, adjust it as follows:

1. Clamp the arm on the rest.
2. Set the canceller knob to "0.5".
3. Remove the PU base plate, adjust gear A so that the canceller spring is in the position of Fig. 16.
4. Mount the PU base plate onto the arm base and check the spring position.

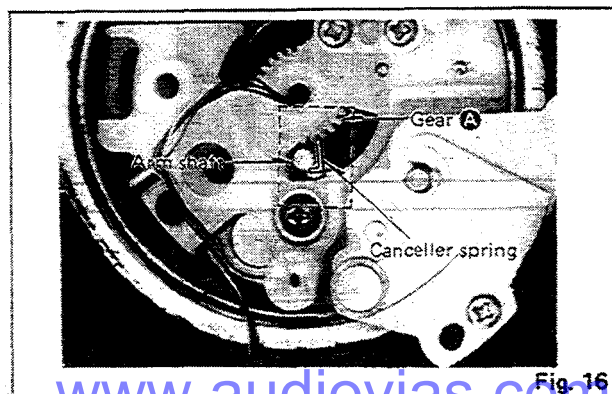

Fig. 16

■ ADJUSTMENTS

Pitch control (fine adjustment of speed) (See Figs. 18 and 19.)

When the pitch control knob is located at the center of the position after turning on the power, the green LED indicator is lit showing the operating condition for the predetermined speed (either 33-1/3 or 45 rpm). The pitch control is variable in a range of about $\pm 8\%$

Adjustment should be done on the basis of indicator scale. Figures on the indicator show approximate percentages for variable pitch control.

When the strobe dots in 4 stages marked at the peripheral edge of the turntable appear to be stationary, variation of individual pitches is shown. (See Fig. 19.)

Note:

The strobe-illumination of this unit employs a strobe-illuminator LED synchronized with the precise quartz frequency.

For fine adjustment of the turntable speed, be sure to effect the adjustment according to the LED illumination.

The LED illumination is not synchronized with fluorescent lamps.

Adjustment of arm-lift height (See Figs. 20 and 21.)

The arm-lift height (distance between the stylus tip and record surface when cueing lever is raised) has been adjusted at the factory before shipping to approximately 8-13mm.

If the clearance becomes too narrow or too wide, turn the adjustment screw clockwise or counterclockwise, while pushing the arm lift down.

Clockwise rotation

—distance between the record and stylus tip is decreased.

Counterclockwise rotation

—distance between the record and stylus tip is increased.

Note:

As the adjusting screw has hexagonal head, be sure to make the adjustment while depressing the arm lift, or the screw will not move freely.

Also be sure that the hexagonal head retracts correctly into the arm lift when the latter is released.

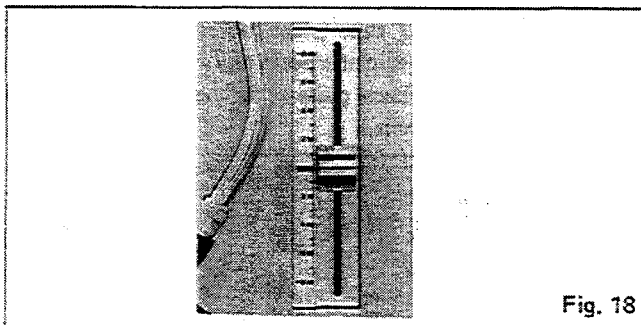

Fig. 18

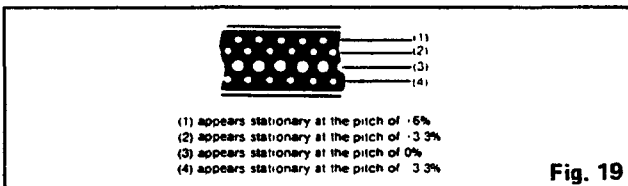

Fig. 19

Adjustment of the tonearm height (See Fig. 22.)

The height of the tonearm can be adjusted up to 6 mm, and a scale is provided on the adjust ring in 0.5 mm increments. Be sure to set the proper arm height using the adjust ring scale and referring to the table.

Height of cartridge (H) (mm)	Scale reading on the arm-height adjust ring
15	0
16	1
17	2
18	3
19	4
20	5
21	6

For example, if the cartridge height is 17.5 mm, the arm-height adjust ring should be positioned at the intermediate location between 2 and 3 on the scale. (See Fig. 22.)

Caution:

Be sure to lock the tonearm by turning the arm lock knob in the direction indicated by the arrow after finishing the height adjustment for the tonearm.

Lubrication (See Fig. 23.)

Apply 2 or 3 drops of oil once after every 2000 hours of operation.

The time interval is much longer than that for conventional type motors (200-500 hours).

Please purchase original oil. (Part number is SFWO 010.)

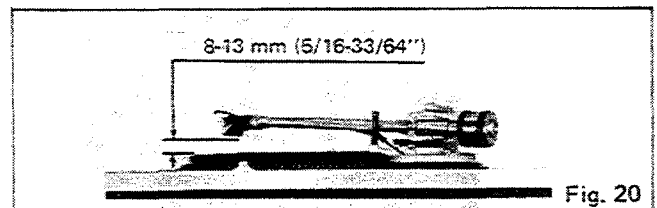

Fig. 20

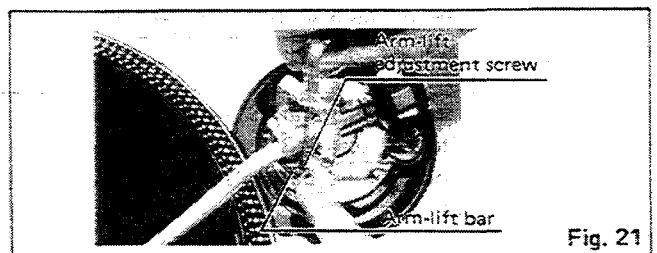

Fig. 21

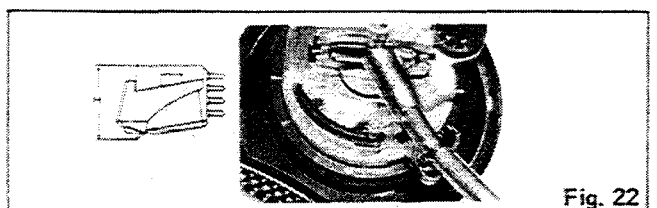

Fig. 22

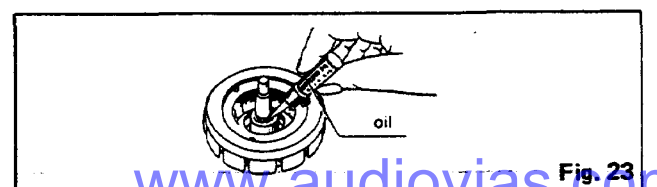

Fig. 23

■ JUSTIERUNGEN

Drehzahl-Feineinstellung (Vgl. Abb. 18 und 19.)

Wenn der Drehzahl-Feineinsteller beim Einschalten der Stromzufuhr in seiner mittleren Stellung ist, leuchtet der grüne LED-Anzeiger auf und zeigt den Betriebszustand für die vorgewählte Drehzahl (entweder 33-1/3 oder 45 U/min) an. Die Drehzahl ist über einen Bereich von ca. ±8% regelbar.

Die Zahlen auf dem Anzeiger geben ungefähre Prozentzahlen für die Drehzahlregulierung an.

Wenn eine der vier Atroboskoppunkte in der Plattenellerrand stationär zu bleiben scheint, so wird dadurch die entsprechende Drehzahlabweichung (bzw. Nenndrehzahl) angezeigt. (Vgl. Abb. 19.)

Anmerkung:

Die Stroboskopbeleuchtung dieses Plattenspielers verwendet eine Stroboskop-LED-Lampe, die mit der präzisen Quarzfrequenz synchronisiert ist.

Die Drehzahl-Feineinstellung muß unter der Beleuchtung durch diese LED-Lampe durchgeführt werden. Die LED-Lampe ist nicht mit Leuchtstofflampen synchronisiert.

Justierung der Tonarmflifthöhe (Vgl. Abb. 20 und 21.)

Die Tonarmflifthöhe, d.h. der Abstand zwischen Nadelspitze und Schallplattenoberfläche, wenn der Lift-Hebel angehoben ist, ist werkseitig auf ungefähr 8–13 mm eingestellt worden.

Falls der Abstand zu groß oder zu klein wird, drehen Sie die Justierschraube im Uhrzeigersinn oder Gegenuhrzeigersinn während Sie die Tonarmflifthöhe nach unten drücken.

Drehung im Uhrzeigersinn

—Der Abstand wird kleiner.

Drehung im Gegenuhrzeigersinn

—Der Abstand wird größer.

■ JUSTIERUNGEN (Elektrisch)

- Anmerkung:
- Nach Teilerneuerung von z.B. IC, Transistor, Diode usw. die folgenden Abgleichungen vornehmen.
 - Einstellung des Gerätes
 1. Netzschalter ----- ON
 2. Tonhöhe Kontrolle ----- Mittlere Stellung.

3. Drehzahlwähler ----- 33 U/min.
- Zu verwendende Instrumente
 1. Prüfgerät
 2. Signalfrequenzmesser

Abgleichung	Anschlußpunkte	Abgleichpunkte	Abgleichmethode
A Abgleich der Tonhöhenkontrolle ±0% (PITCH)	Signalfrequenzmesser ⊕ TP27 ⊖ GROUND	VR301	1. Schalter für Tonhöhenkontrolle auf Mittelstellung. 2. VR301 auf 262,08 kHz ±0,05 kHz abgleichen.
B Abgleich des Tonhöhesteuergewinns	Prüfgerät TP31 und TP32	VR302	VR302 auf 2,7K ±0,1 des Widerstandswertes einstellen.
C Bremsen Justierung (BRAKE)	—	VR201	VR201 innerhalb 120°~270° nach Haltsignalanzeige auf Kompletten Halt Justieren. (Plattenteller wird ein paar Sekunden nach Halt frei.) Haltsignal 

Anmerkung:

Da die Justierschraube einen Sechskantkopf hat, muß die Tonarmflifthöhe während des Justierens unbedingt gedrückt gehalten werden, damit sich die Schraube leicht drehen läßt.

Vergewissern Sie sich, daß der Sechskantkopf in die Tonarmflifthöhe zurückkehrt, wenn diese losgelassen wird.

Justierung des Antiskating-Einstellers

Stellen Sie den Antiskating-Einstellknopf auf den gleichen Wert ein, wie den Auflagedruck. (Vgl. Abb. 13.)

Justierung der Tonarmhöhe (Vgl. Abb. 22.)

Die Tonarmhöhe kann mittels eines Justierings, dessen Skala in Stufen von 0,5 mm unterteilt ist, um bis zu 6mm reguliert werden. Nehmen Sie die Justierung gemäß nachstehender Tabelle vor.

Tonabnehmerhöhe (mm) (H)	Skalaeinstellung auf dem Tonarmhöhe-Justiering
15	0
16	1
17	2
18	3
19	4
20	5
21	6

Falls die Tonarmhöhe beispielsweise 17,5 mm beträgt, sollte der Justiering zwischen die Skalaeinstellungen 2 und 3 eingestellt werden. (Vgl. Abb. 22.)

Achtung:

Nach erfolgter Tonarmhöhe-Justierung muß der Tonarm unbedingt durch Drehen des Tonarmverriegelungskopfs in der Pfeilrichtung festgestellt werden.

■ REGLAGES

Réglage d'écart (mise au point exacte de la vitesse) (Voir Figs. 18 et 19.)

Lorsque la manette de réglage d'écart est située à la position centrale une fois l'alimentation mise en marche, l'indicateur à diode électro-luminescente (LED) verte s'éclaire pour indiquer la condition de fonctionnement de la vitesse prédéterminée (soit 33-1/3 ou 45 t/p.m.). Le réglage d'écart est ajustable dans une plage d'à peu près 8%.

La mise au point devra être faite en se basant sur la graduation de l'indicateur. Les chiffres sur l'indicateur montrent les pourcentages approximatifs pour un réglage d'écart variable.

Lorsque les points stroboscopiques sur les quatre gradins du bord périphérique du plateau semblent être immobiles, la variation des écarts individuels est représentée. (Voir Fig. 19.)

Nota:

L'éclairage stroboscopique de cet appareil utilise un illuminomètre stroboscopique à diodes électro-illuminéscentes (LED) synchronisé avec une fréquence à quartz précise.

Pour une mise au point exacte de la vitesse du plateau, s'assurer d'effectuer le réglage selon l'éclairage de la diode électro-luminescente.

L'éclairage à diodes électro-luminescentes ne se synchronise pas avec l'utilisation de lampes fluorescentes.

Mise au point de la hauteur de l'élevateur du bras (Voir Figs. 20 et 21.)

La hauteur de l'élevateur du bras (distance entre l'extrémité de la pointe de lecture et la surface du disque lorsque le levier de pose et de relevage du bras est soulevé) a été réglée en usine avant son départ sur une valeur approximative de 8 – 13 mm.

Si l'écartement devient trop étroit ou trop large, tourner la vis de réglage dans le sens des aiguilles d'une montre ou en sens inverse, tout en abaissant l'élevateur du bras.

Rotation dans le sens des aiguilles d'une montre.

—La distance entre la surface du disque et l'extrémité de la pointe de lecture diminue.

■ REGLAGES (Electricité)

- Notes:
- Effectuer les réglages suivants après avoir remplacé des éléments tels que les IC, transistors, diodes, et autres.
 - Etat de l'appareil
 1. Commutateur d'alimentation ----- Marche
 2. Commande d'alignement de la vitesse ----- Position centrale

Rotation dans le sens contraire des aiguilles d'une montre.
—La distance entre la surface du disque et l'extrémité de la pointe de lecture augmente.

Nota:

Comme le vis de réglage possède une tête hexagonale, s'assurer d'effectuer la mise au point tout en abaissant l'élevateur du bras, sinon la vis ne bougera pas librement. Vérifier aussi que la tête hexagonale se retire correctement dans l'élevateur du bras quand ce dernier est libéré.

Mise au point de la hauteur du bras de lecture (Voir Fig. 22.)

La hauteur du bras de lecture peut être réglée jusqu'à 6 mm et une graduation est disposée sur la bague de réglage par augmentation de 0,5 mm. S'assurer de régler convenablement la hauteur du bras en utilisant la graduation de la bague et en se référant au tableau ci-dessous.

Hauteur de la cellule de lecture (mm) (H)	Lecture de la graduation sur la bague de réglage de la hauteur du bras
15	0
16	1
17	2
18	3
19	4
20	5
21	6

Par exemple, si la hauteur de la cellule de lecture est de 17,5 mm, la bague de réglage de la hauteur du bras devra être positionnée à l'emplacement intermédiaire entre les lectures de la graduation 2 et 3 indiquées sur la graduation. (Voir Fig. 22.)

Avertissement:

S'assurer de bloquer le bras de lecture en tournant la manette de blocage du bras dans la direction indiquée par la flèche, après avoir terminé la mise au point de la hauteur du bras de lecture.

3. Commutateur du sélecteur de vitesse ----- 33-1/3 trs/mn. Appareils à utiliser
- Appareils à utiliser
 1. Contrôleur
 2. Fréquence-mètre

Réglage	Points de connexion	Points de réglage	Méthode de réglage
A Réglage de la commande d'alignement de la vitesse, ±0% (PITCH)	Fréquence-mètre ⊕ TP27 ⊖ TERRE	VR301	1. Commutateur de commande d'alignement de la vitesse en position centrale 2. Régler la VR301 sur une fréquence de 262,08 kHz ±0,05 kHz
B Réglage du gain de commande de la vitesse de rotation du plateau	Contrôleur TP31 et TP32	VR302	Régler la VR302 sur la valeur de la résistance de 2,7K ±0,1
C Réglage du frein (BRAKE)	—	VR201	Régler la VR201 sur l'envoi du signal d'arrêt. (Le plateau devient libre quelques secondes après l'arrêt.) Signal d'arrêt 

Schematic Diagram (This schematic diagram may be modified at any time with the development of new technology.)

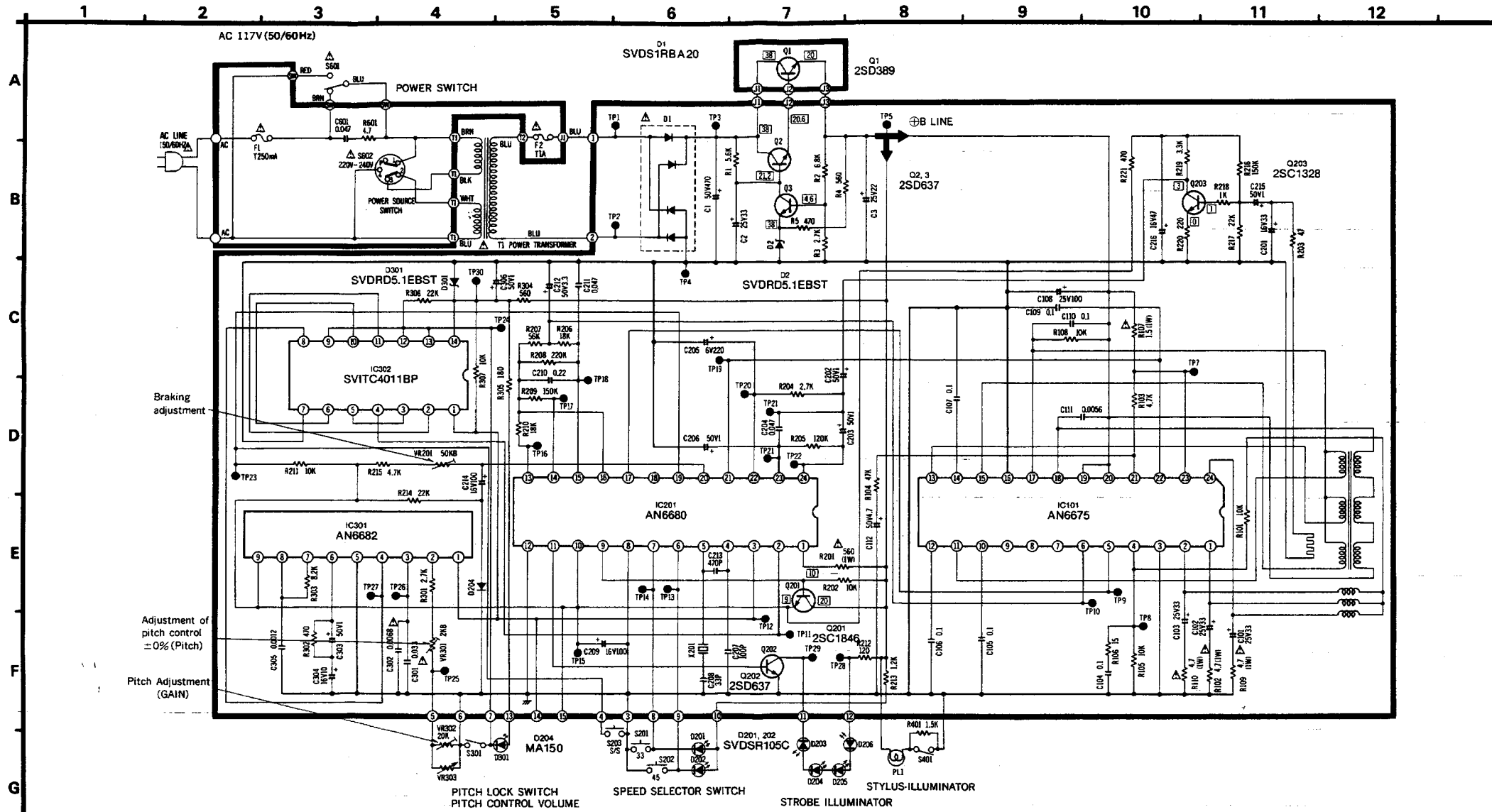

■ TERMINAL GUIDE OF TRANSISTOR AND IC

AN6675	AN6680	AN6682	SVTC4011BP	2SC1846	2SC1328	2SD637	2SD389

- NOTE:**
- S201: Speed selector switch (33-1/3 r.p.m.) in "ON" position, (push condition)
 - S202: Speed selector switch (45 r.p.m.) in "OFF" position, (not-push condition)
 - S203: Start/Stop switch in "OFF" position, (not-push condition)
 - S301: Pitch lock switch in "ON" position, (center position)
 - S401: Stylus-illuminator switch in "OFF" position.
 - S601: Power switch in "ON" position.
 - S602: Power source switch in "220-240V" position.
 - The drive circuit IC voltage and wave form are not indicated in side the schematic diagram.
 - Indicated voltage value are the standard values for the unit measured by DC electronic circuit tester (high impedance) with the chassis taken as standard. Therefore, there may exist some errors in the voltage values, depending on the internal impedance of the DC circuit tester.
 - ⚠ indicates that only parts specified by the manufacturer be used for safety.

REPLACEMENT PARTS LIST (Electrical)

- Notes:**
- Part numbers are indicated on most mechanical parts. Please use this number for parts orders.
 - Δ indicates that only parts specified by manufacturer be used for safety.
 - SL-1200MK2 (XG) \rightarrow [XG], SL-1200MK2 (XA) \rightarrow [XA], SL-1200MK2 (XGB) \rightarrow [XGB]
SL-1200MK2 (XAL) \rightarrow [XAL], SL-1200MK2 (E) \rightarrow [E]

Ref. No.	Part No.	Part Name & Description
INTEGRATED CIRCUITS		
IC101	AN6675	Integrated Circuit
IC201	AN6680	Integrated Circuit
IC301	AN6682	Integrated Circuit
IC302	SVITC4011BP	Integrated Circuit
TRANSISTORS		
Q1	2SD389A-Q	Transistor
Q2, 3, 202	2SD637	Transistor
Q201	2SC1846-R	Transistor
Q203	2SC1328-T	Transistor
DIODES		
D1	Δ SVDS1RBA40	Rectifier
D2, 301	MA1051	Diode, Zener 5.1V
D204	MA162A	Diode
D201, 202	SVDSR-105C	Light Emitting Diode
D203~206	SVDEBR5505S	Light Emitting Diode
D301	SV DGL-9PG2	Light Emitting Diode
CRYSTAL		
X201	SVQU306115	Crystal, 4.19328MHz Oscillator
VARIABLE RESISTORS		
VR201	EVLS6AA00B54	Braking Adjustment (BRAKE), 50k Ω (B)
VR301	EVMH2GA00B53	Adjustment of Pitch Control \pm 0%(PITCH), 5k Ω (B)
VR302	EVLS6AA00B54	Pitch Adjustment (Gain) 50k Ω
VR303	EVBJ05C19ABE	Pitch Control Volume
SWITCHES		
S201	EVQP5R04K	Switch, Speed Selector (33-1/3 r.p.m.)
S202	EVQP5R04K	Switch, Speed Selector (45 r.p.m.)
S203	SFDSS5GL13C	Switch, Start/Stop
S401	SFDSD2MSL-4	Switch, Stylus-illuminator
S601	Δ SFDSS5GL13S	Switch, Power
S602	Δ SFD SHXW01317	Switch, Power Source
LAMP		
PL1	SFDN172-01	Lamp, Stylus-illuminator
TRANSFORMER		
T1	Δ SLTF5900	Power Transformer
FUSE		
F1	Δ XBA2C025T1A	Fuse, T250 mA
F2	Δ XBA2C10TRO	Fuse, T1A
RESISTORS		
R1	ERD25FJ562	Carbon, 5.6k Ω , 1/4W, \pm 5%
R2	ERD25FJ682	Carbon, 6.8k Ω , 1/4W, \pm 5%
R3	ERD25FJ272	Carbon, 2.7k Ω , 1/4W, \pm 5%
R4	ERD25FJ561	Carbon, 560 Ω , 1/4W, \pm 5%
R5	ERD25FJ471	Carbon, 470 Ω , 1/4W, \pm 5%
R101	ERD25FJ103	Carbon, 10k Ω , 1/4W, \pm 5%
R102	Δ ERX1ANJ4R7	Metal Film, 4.7 Ω , 1W, \pm 5%
R103	ERD25FJ472	Carbon, 47k Ω , 1/4W, \pm 5%
R104	ERD25TJ473	Carbon, 47k Ω , 1/4W, \pm 5%
R105	ERD25FJ103	Carbon, 10k Ω , 1/4W, \pm 5%
R106	ERD25FJ150	Carbon, 15 Ω , 1/4W, \pm 5%

Ref. No.	Part No.	Part Name & Description
R107	Δ ERX1ANJ1R5	Metal Film, 1.5 Ω , 1W, \pm 5%
R108	ERD25FJ103	Carbon, 10k Ω , 1/4W, \pm 5%
R109, 110	Δ ERX1ANJ4R7	Metal Film, 4.7 Ω , 1W, \pm 5%
R201	Δ ERG1ANJ561	Metal Oxide, 560 Ω , 1W, \pm 5%
R202	ERD25FJ103	Carbon, 10k Ω , 1/4W, \pm 5%
R203	ERD25FJ470	Carbon, 47 Ω , 1/4W, \pm 5%
R204	ERD25FJ272	Carbon, 2.7k Ω , 1/4W, \pm 5%
R205	ERD25TJ124	Carbon, 120k Ω , 1/4W, \pm 5%
R206	ERD25TJ183	Carbon, 18k Ω , 1/4W, \pm 5%
R207	ERD25TJ563	Carbon, 56k Ω , 1/4W, \pm 5%
R208	ERD25TJ224	Carbon, 220k Ω , 1/4W, \pm 5%
R209	ERD25TJ154	Carbon, 150k Ω , 1/4W, \pm 5%
R210	ERD25TJ183	Carbon, 18k Ω , 1/4W, \pm 5%
R211	ERD25FJ103	Carbon, 10k Ω , 1/4W, \pm 5%
R212	ERD25FJ121	Carbon, 120 Ω , 1/4W, \pm 5%
R213	ERD25FJ122	Carbon, 1.2k Ω , 1/4W, \pm 5%
R214	ERD25TJ223	Carbon, 22k Ω , 1/4W, \pm 5%
R215	ERD25FJ472	Carbon, 4.7k Ω , 1/4W, \pm 5%
R216	ERD25TJ154	Carbon, 150k Ω , 1/4W, \pm 5%
R217	ERD25TJ223	Carbon, 22k Ω , 1/4W, \pm 5%
R218	ERD25FJ102	Carbon, 1k Ω , 1/4W, \pm 5%
R219	ERD25FJ332	Carbon, 3.3k Ω , 1/4W, \pm 5%
R220	ERD25FJ221	Carbon, 220 Ω , 1/4W, \pm 5%
R221	ERD25FJ471	Carbon, 470 Ω , 1/4W, \pm 5%
R301	ERO25CKF3301	Metal Film, 3.3k Ω , 1/4W, \pm 1%
R302	ERD25FJ471	Carbon, 470 Ω , 1/4W, \pm 5%
R303	ERD25FJ822	Carbon, 8.2k Ω , 1/4W, \pm 5%
R304	ERD25FJ152	Carbon, 1.5k Ω , 1/4W, \pm 5%
R306	ERD25TJ223	Carbon, 22k Ω , 1/4W, \pm 5%
R601	ERD25FJ4R7	Carbon, 4.7 Ω , 1/4W, \pm 5%
CAPACITORS		
C1	ECEB1HS471	Electrolytic, 470 μ F, 50V
C2	ECEA1VS330	Electrolytic, 33 μ F, 35V
C3	ECEA1ES220	Electrolytic, 22 μ F, 25V
C101, 102	ECEA1VS330	Electrolytic, 33 μ F, 35V
C103	ECEA1VS330	Electrolytic, 33 μ F, 35V
C104, 105	ECQM1H104KZ	Polyester, 0.1 μ F, 50V, \pm 10%
C106, 107	ECQM1H104KZ	Polyester, 0.1 μ F, 50V, \pm 10%
C108	ECEA1ES101	Electrolytic, 100 μ F, 25V
C109, 110	ECQM1H104KZ	Polyester, 0.1 μ F, 50V, \pm 10%
C111	ECQM1H562KZ	Polyester, 0.0056 μ F, 50V, \pm 10%
C112	ECEA1JS4R7	Electrolytic, 4.7 μ F, 63V
C201	ECEA1CS330	Electrolytic, 33 μ F, 16V
C202, 203	ECEA50Z1	Electrolytic, 1 μ F, 50V
C204	ECQM1H473KZ	Polyester, 0.047 μ F, 50V, \pm 10%
C205	ECEA1AS221	Electrolytic, 220 μ F, 10V
C206	ECEA50Z1	Electrolytic, 1 μ F, 50V
C207	ECCD1H101K	Ceramic, 100pF, 50V, \pm 10%
C208	ECCD1H390K	Ceramic, 39pF, 50V, \pm 10%
C209	ECEA1ES101	Electrolytic, 100 μ F, 16V
C210	ECQM1H224KZ	Polyester, 0.22 μ F, 50V, \pm 10%
C211	ECQM1H473KZ	Polyester, 0.047 μ F, 50V, \pm 10%
C212	ECEA50Z3R3	Electrolytic, 3.3 μ F, 50V
C213	ECCD1H471K	Ceramic, 470pF, 50V, \pm 10%
C214	ECEA1ES101	Electrolytic, 100 μ F, 25V
C215	ECEA50Z1	Electrolytic, 1 μ F, 50V
C216	Δ ECEA1ES470	Electrolytic, 47 μ F, 25V
C301, 302	ECQK1123FZ	Polyester, 0.012 μ F, 125V, \pm 1%
C303	ECEA50Z1	Electrolytic, 1 μ F, 50V
C304	ECEA1HS100	Electrolytic, 10 μ F, 50V
C305	ECQM1H122KZ	Polyester, 0.0012 μ F, 50V, \pm 10%
C306	ECEA50Z1	Electrolytic, 1 μ F, 50V
C601	ECNC4A473M	Paper, 0.047 μ F, 400V, \pm 20%

■ TROUBLE SHOOTING

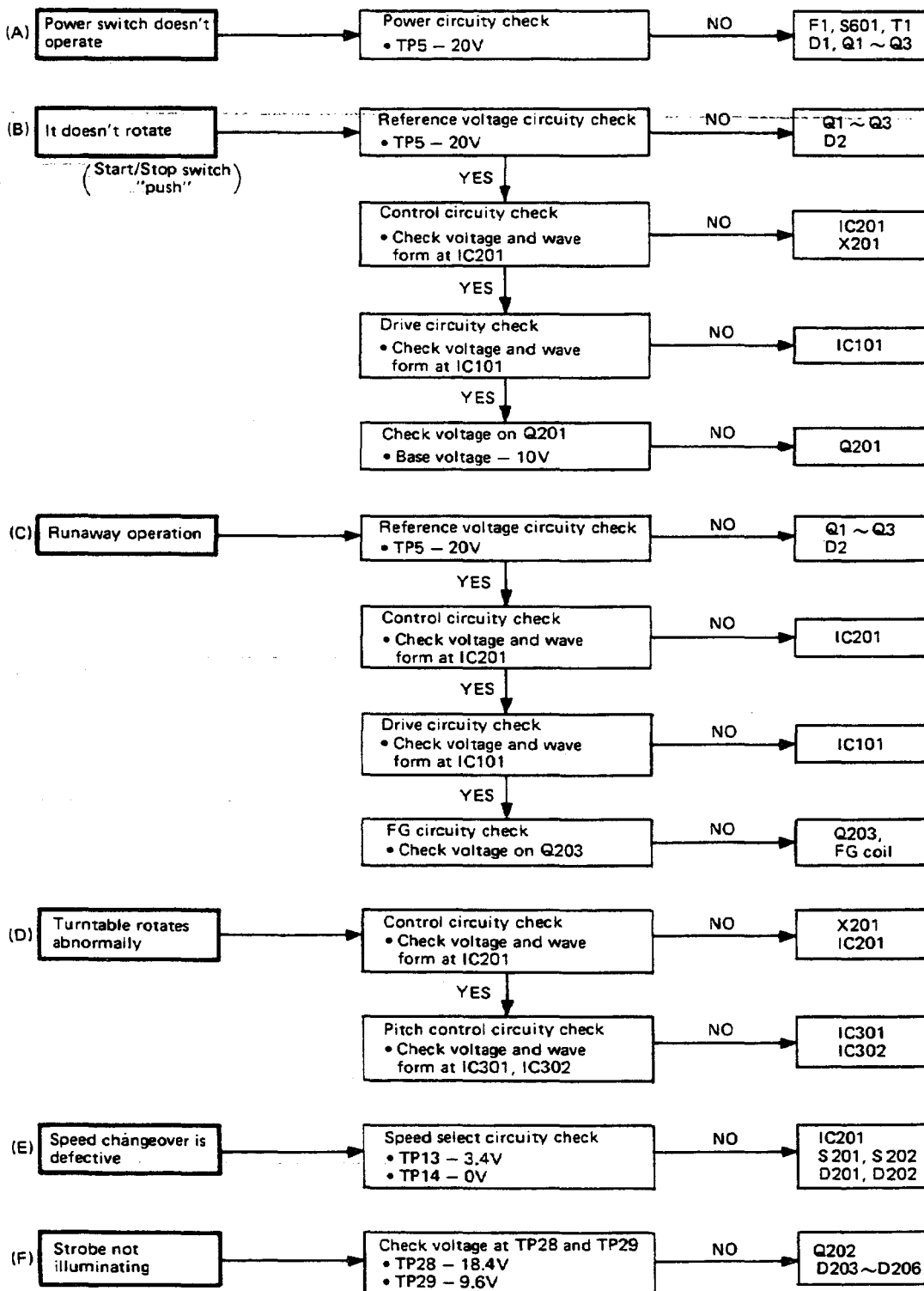

Printed Circuit Board

■ + B'line
■ Earth (Ground) lines

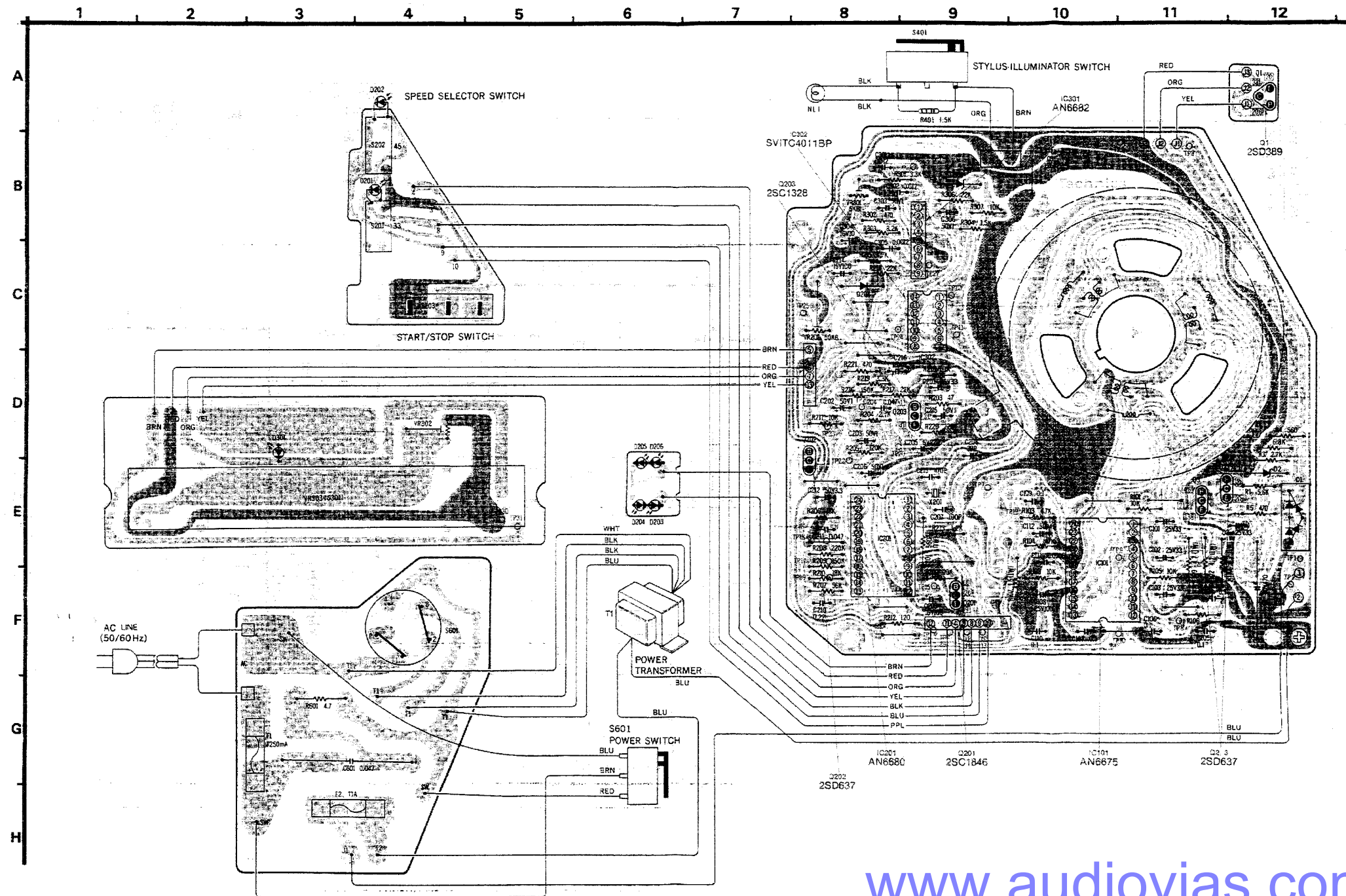

SL-1200MK2 SL-1200MK2

■ BLOCK DIAGRAM

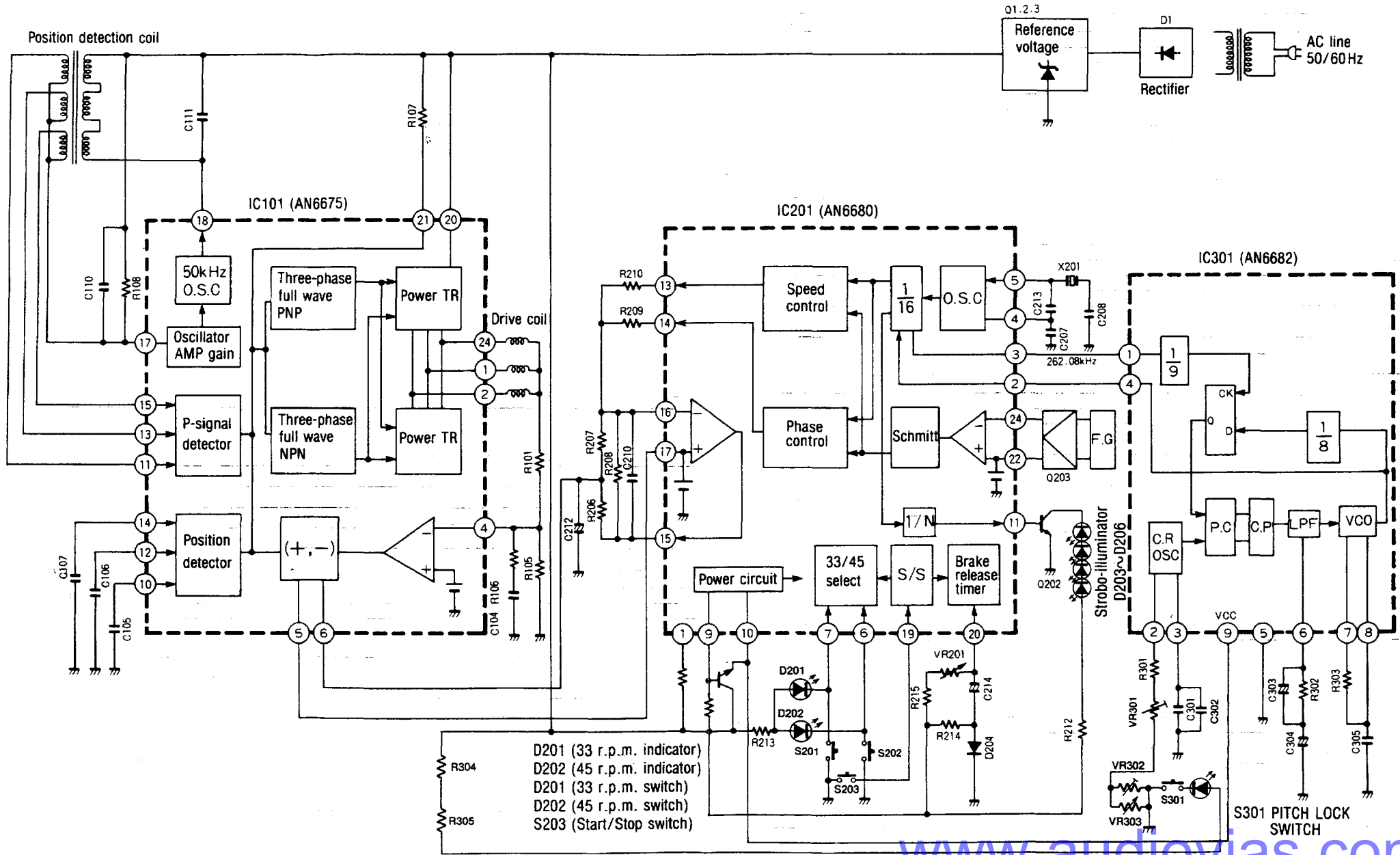

■ ADJUSTMENT (Electrical)

Notes: ● Make the following adjustments after replacing parts such as IC's, transistors, diodes, etc.

- Condition of the set.
 1. Power switch ON
 2. Pitch control Center position
 3. Speed selector switch 33-1/3 r.p.m.
- Instruments to be used
 1. Tester
 2. Frequency counter

Adjustment	Connection Points	Adjustment Point	Adjustment Method
A Adjustment of pitch control $\pm 0\%$ (PITCH)	Frequency counter ⊕ — TP27 ⊖ — GROUND	VR301	1. Pitch control switch to center position. 2. Adjust VR301 for 262.08 kHz ± 0.05 kHz of frequency.
B Adjustment of pitch control gain	Tester TP31 and TP32	VR302	Adjust VR302 for 2.7 k Ω ± 0.1 of resistance value
C Braking adjustment (BRAKE)	—	VR201	Adjust VR201 for complete stop within 120° ~ 270° after stop signal initiated. (Turntable becomes free a few seconds after stop) <div style="text-align: center;"> <p>STOP SIGNAL</p> <p>270° — Turntable — 120°</p> </div>

■ REFERENCE VOLTAGE AND WAVEFORM AT EACH IC PIN

PIN

IC101 (AN6675)

	Start	Stop		Start	Stop		Start	Stop				
①	2V	2V			15V		Same as at right					
②	2V	2V							⑫	⑮	20V	20V
③	0V	0V							⑬	⑯	20V	20V
④	5V	5V							⑭	⑰	20V	20V
⑤	5V	5V							⑱	⑲	20V	20V
⑥	5V	6.6V							⑲	⑲	20V	20V
⑦	0V	0V							⑳	⑳	20V	20V
⑧	5V	5V							㉑	㉑	0.2V	0.2V
⑨	0V	0V							㉒	㉒	-20V	20V
⑩	15V	15V							㉓	㉓	1.7V	1.7V
⑪	15V	15V							㉔	㉔	15V	15V

IC201 (AN6680)

	Start	Stop		Start	Stop		Start	Stop	
①	2.5V	2.5V		⑧	0V	0V	⑮	5V	2.5V
②	Same as at right			⑨	9.8V	9.8V	⑰	5V	5V
				⑩	10V	10V	⑱	0V	0V
③	Same as at right			⑪	Same as at right		⑲	7.5V	0V
							⑳	0V	5V
④	Same as at right			⑫	0V	0V	㉑	3V	3V
							⑮	0.2V	0.2V
⑤	Same as at right			⑬			㉒	2.8V	2.8V
							⑩		
⑥	3.4V	3.4V		⑭		8V			
⑦	0V	0V							

IC301 (AN6682)

	Start	Stop		Start	Stop		Start	Stop	
①	Same as at right			④	Same as at right		⑧	Same as at right	
②	Same as at right			⑤	0V	0V	⑨	9V	9V
				⑥	3.9V	3.9V			
③	Same as at right			⑦	Same as at right				

IC302 (5V) IC4011BP)

	Start	Stop		Start	Stop		Start	Stop	
①	Same as at right			⑤	Same as at right		⑨	5V	5V
②	5V	5V		⑥	5V	5V	⑩	5V	5V
				⑦	0V	0V	⑪	5V	5V
③	Same as at right			⑧	Same as at right		⑫	0.6V	0.6V
							⑬	0.6V	0.6V
④	5V	5V					⑭	5V	5V

Q202 (2SD637)

	Start	Stop
E	0V	0V
C	Same as at right	
B	Same as at right	

EXPLODED VIEWS

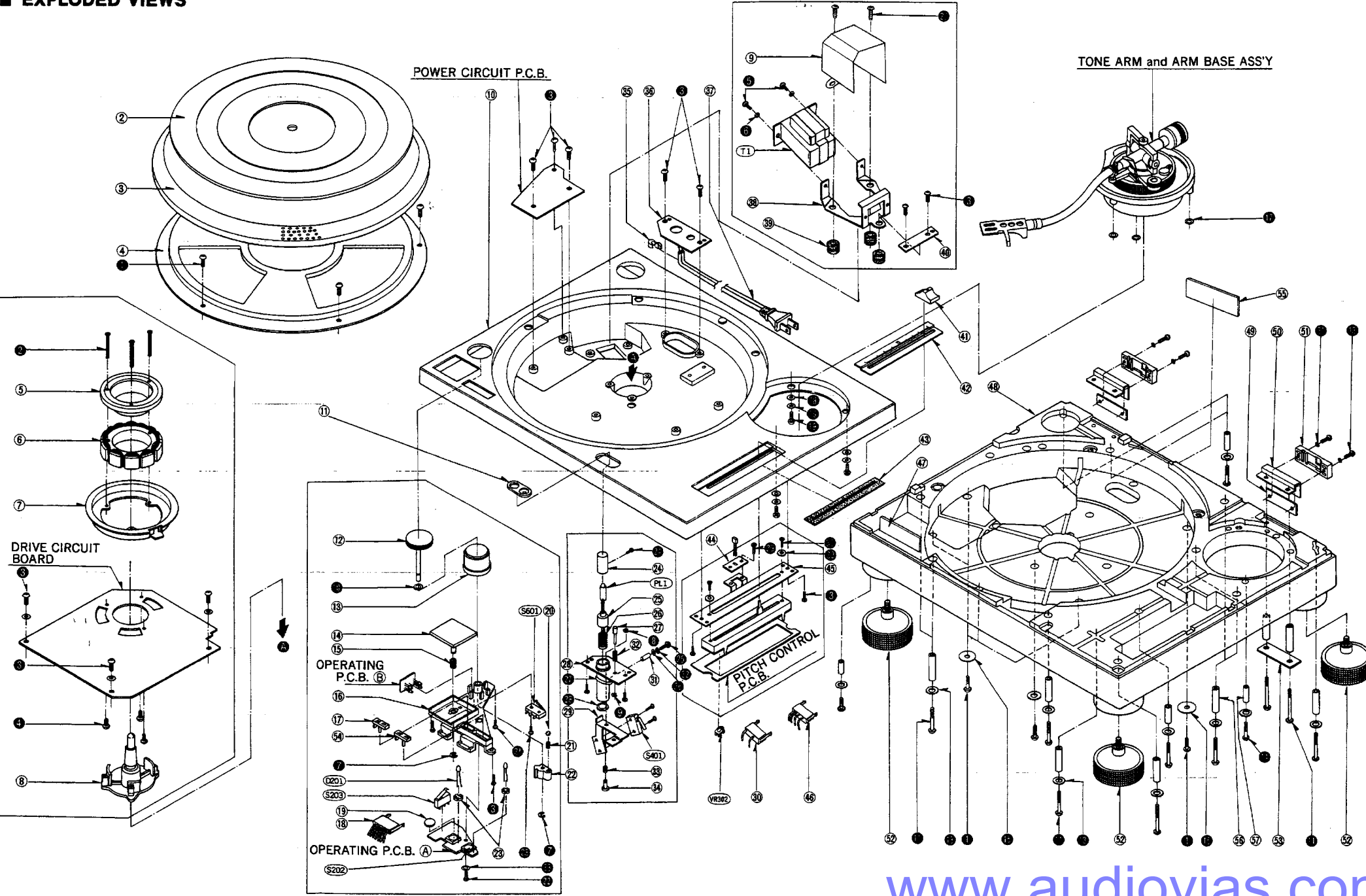

REPLACEMENT PARTS LIST (Mechanical)

- Notes:** 1. Part numbers are indicated on most mechanical parts.
 Please use this number for parts orders.
 2. **Δ** indicates that only parts specified by manufacturer be used for safety.
 3. SL-1200MK2 (XG) → [XG], SL-1200MK2 (XA) → [XA], SL-1200MK2(XGB) → [XGB]
 SL-1200MK2 (XAL) → [XAL], SL-1200MK2 (E) → [E]

Ref. No.	Part No.	Part Name & Description
CABINET and CHASSIS PARTS		
1	SFAD122-01A	Dust Cover
2	SFTG172-01	Turntable Mat
3	SFTE172-01Z	Turntable
4	SFUM172-05	Cover, Turntable
5	SFMG20-01	Cover, Stator Frame Ass'y
6	SFMG520-31A	Stator Frame
7	SFMA172-01E	FG Detector Coil Ass'y
8	SFMG20-01A	Shaft, Stator Frame Ass'y
9	SFUP122-12	Plate, Shield
10	SFAC122-01	Cabinet
11	SFUM172-04	Ornament, Stylus-Illuminator
12	SFKT122-01	Knob, Power Switch
13	SFKK122-01E	Case, Strobe-Illuminator
14	SFKT015-06	Knob, Start/Stop Switch
15	SFQA122-01	Spring, Start/Stop Knob
16	SFUM122-01	Base, Operation
17	SFKT015-01E	Knob, Speed Selector (33-1/3 r.p.m.)
18	SFDJ122-02E	Connector, 7-PIN
19	SFGZ122-01	Spacer, Rubber (Speed Selector)
20	SFYB5-32	Ball, Switch Cam
21	SFQA520-01	Spring, Switch Cam
22	SFUM122-03	Cam, Switch
23	SFUM015-11	Spacer, LED
24	SFKK172-01	Cover, Lamo
25	SFXB122-02	Boss, Drive
26	SFQA172-01	Spring, Drive Boss
27	SFXJ172-01	Pin, Lock Canceler
28	SFUP122-02E	Bracket, Stylus-Illuminator
29	SFUP122-03	Plate, Lock Operation
30	SFDJ122-03E	Connector, 3-PIN
31	SFXO172-01	Pin, Guide
32	SFQA520-01	Spring, Lock Canceler Pin
33	SFQA001-02	Spring, Lock Operating Plate M'tg
34	SFXJ172-05	Pin, Lock Operating Plate M'tg
35 except [XAL]	SFSR4N4	Clamper, AC Cord
35 [XAL] only	SFKH040L	Clamper, AC Cord
36 except [XAL]	SFUP025X01	Bracket, AC Cord
36 [XAL] only	SFUP025-01	Bracket, AC Cord
37 except [XAL]	RJA232C	AC Cord
37 [XAL] only	QFC1208M	AC Cord
38	SFUP132-03	Bracket, Power Transformer
39	SFGC122-01	Cushion, Power Transformer
40	SFUP122-10	Spacer, Power Transformer
41	SFKT122-02	Knob, Pitch Control Volume
42	SFKK122-03	Ornament, Pitch Control Volume
43	SFUZ122-01	Shading Cloth, Pitch Control Volume
44	SFUP122-09	Holder, LED
45	SFUP122-01	Bracket, Pitch Control Volume
46	SFDJ122-01E	Connector, 4-PIN
47	SFUP122-13	Supporter, Bottom Base
48	SFAU122-01	Base, Bottom
49	SFUP122-05	Supporter (A), Hinge
50	SFUP122-04	Supporter (B), Hinge
51	SFUM170-07	Case, Hinge
52	SFGC122-02E	Audio Insulator
53	SFUP122-06	Supporter (C), Hinge
54	SFKT015-02E	Knob, Speed Selector (45 r.p.m.)
55 [XG, XA, XGB]	SFNN122N01	Name Plate
55 [XAL]	SFNN122L01	Name Plate
56 [E].....	SFNN122S01	Name Plate
57	SFXO122-01	Pipe (A)
57	SFXO122-02	Pipe (B)
58	SFAT122-01A	Hinge Ass'y
STONE ARM and ARM BASE		
61	SFPC31001K	Head Shell
62	SFPAM18201K	Tone Arm Ass'y
63	SFPWG17201K	Balance Weight Ass'y
64	SFPRT18201K	Lift Ass'y
65	SFPZB17202	Knob, Arm Base Lock
66	SFQA829-03	Spring, Lift Ass'y
67	SFPAB13202	Knob, Arm Lift
68	SFJL18202K	Oil Damper
70	SFPZB12203	Plate, Arm Base Cover
71	SFUM170-06	Spacer, Phono Cord
72	SFPZB12204	Clamper, Phono Cord
73	SFPAB18201K	Tone Arm Fixing Plate Ass'y

Ref. No.	Part No.	Part Name & Description
74	SFPZB12201K	Plate, Position Fix
75	SFDH028-01	Phono Cord
76	SFEL028-01E	Ground Wire
77	SFPRT17201K	Arm Rest
78	SFPKD17203	Arm Base
79	SFPKB17201S	Ring, Arm Base Operation
80	SFPKD12201	Bracket, Arm Base
81	SFPAB17206	Knob, Anti-skate Force Control
82	SFGK132-01	Cap, Rubber
SCREWS, WASHERS and CIRCLIPS		
●	XTN3+8BFZ	Screw
●	SFXG020-02	Screw
●	XTN3+8B	Screw
●	XTN26+6B	Screw
●	XTN4+10B	Screw
●	XWA4B	Washer
●	XUC3FT	Circlip
●	XUC2FT	Circlip
●	XUC25FT	Circlip
●	SFXW910J02	Washer
●	XTN3+40BFZ	Screw
●	XSN3+10BVS	Screw
●	XWE3F12FZ	Washer
●	XTN3+25BFZ	Screw
●	SFXW122-01	Washer
●	XWE3E10	Washer
●	SFPEW1100	Washer
●	SFPEW11003	Washer
●	XSN3+8S	Screw
●	SFXG132-01	Screw
●	XTV3+8BFN	Screw
●	XTN3+10B	Screw
●	XTN2+10B	Screw
●	XSN17+3FY	Screw
●	XSN3+14S	Screw
●	SFXW172-04	Washer
●	XUB14FT	Circlip
●	SFUZ172-05	O Ring
●	XTN3+6B	Screw
●	XSN3+6S	Screw
●	XWA3BFZ	Washer
●	XWA3B	Washer
●	XWG3	Washer
●	SFXG829-1	Screw
●	XUC5FT	Circlip
●	XTW3+6B	Screw
●	XTV3+8BFN	Screw
●	XWE410EW	Washer
●	XTN3+25B	Screw
●	XYN3+C6FZS	Screw
●	XSN3+12BVS	Screw
●	SFPEW17201	Washer
●	XWG26	Washer
ACCESSORIES		
A1 except [E]	SFNU122X01	Instruction Book
A1[E] only	SFNU122S01	Instruction Book
A2	SFWE010	Adaptor, 45 r.p.m.
A3	SFPEN3302	Nut, Cartridge
A4	SFPEW9601	Washer, Cartridge
A5	SFCZV8801	Screw, Cartridge
A6	SFPEV9801	Screw, Cartridge
A7	SFKO135-01	Overhang Gauge
A8	SFPZB3501	Shell Weight
A9 [XA] only	SFDKI19118	Plug, 2-PIN
PACKINGS		
P1	SFHP122M01	Carton
P2	SFHH122-01	Pad, Front
P3	SFHH122-02	Pad, Rear
P4	SFHD122-01	Pad, Top
P5	SFHD122-02	Pad, (A), Turntable
P6	SFHD122-03	Pad, (B), Turntable
P7	SFYH60X60	Polyethylene Cover, Turntable Unit and Dust Cover
P8	SFYH40X45	Polyethylene Cover, Turntable

EXPLODED VIEWS

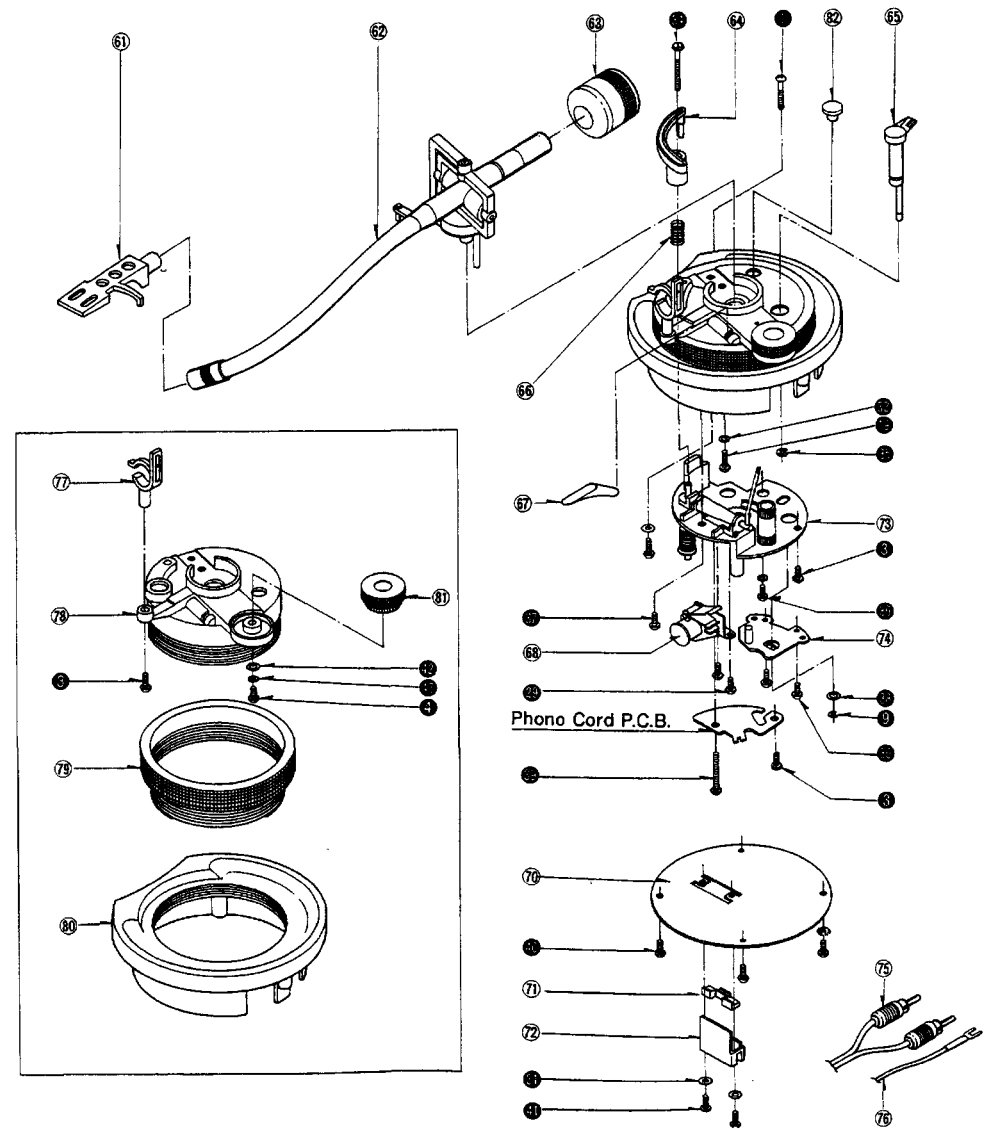

**Panasonic
Technics**

audiovias.com

Panasonic Service Dokumentations-Center

**Schaltungsdienst
Lange o.H.G.**

Verlag Technischer Druckschriften

Postfach 47 06 53
D-12315 Berlin

Telefon 0 30/723 81-3
Telefax 0 30/723 81 500

www.audiovias.com